



# governmentattic.org

*"Rummaging in the government's attic"*

Description of document: **US Department of the Army Civil Disturbance Plan  
"GARDEN PLOT" 10-September-1968**

Requested date: 23-February-2009

Released date: 24-March-2009

Posted date: 09-September-2009

Source of document: U.S. Army Center for Military History  
103 Third Ave., Building 35  
ATTN: DAMH-FPR  
Fort McNair, DC 20319-5058  
Fax: (202) 685-4593

Note: The DOD Civil Disturbance Plan, nicknamed "GARDEN PLOT", was superseded after the events of September 11, 2001. The replacement to Garden Plot is Concept Plan (CONPLAN) 2502, also confusingly known as CONPLAN 3502, and is the responsibility of U. S. Northern Command. It may be requested under FOIA by writing to:

HQ NORAD USNORTHCOM/CS  
ATTN: FOIA OFFICER  
250 VANDENBERG STREET  
SUITE B016  
PETERSON AFB CO 80914-3804

See following page for other available GARDEN PLOT documents.

The governmentattic.org web site ("the site") is noncommercial and free to the public. The site and materials made available on the site, such as this file, are for reference only. The governmentattic.org web site and its principals have made every effort to make this information as complete and as accurate as possible, however, there may be mistakes and omissions, both typographical and in content. The governmentattic.org web site and its principals shall have neither liability nor responsibility to any person or entity with respect to any loss or damage caused, or alleged to have been caused, directly or indirectly, by the information provided on the governmentattic.org web site or in this file. The public records published on the site were obtained from government agencies using proper legal channels. Each document is identified as to the source. Any concerns about the contents of the site should be directed to the agency originating the document in question. GovernmentAttic.org is not responsible for the contents of documents published on the website.

**Four GARDEN PLOT-related documents are available from governmentattic.org:**

1. US Department of the Army Civil Disturbance Plan “GARDEN PLOT” 10-September-1968 — available here: (**This document**)
2. US Air Force (USAF) Reserve Operations Plan Number 355-10 – Employment of USAF Resources in Civil Disturbances, Nickname: GARDEN PLOT, 15-November-1968 – available here:  
[USAF-ROP355-10\\_GardenPlot\\_1968](#)
3. US Department of the Army Civil Disturbance Plan “GARDEN PLOT” prepared for the Department of Defense (DoD), 3 August 1978 – available here:  
[ArmyCivilDisturbPlanGardenPlot\\_1978.pdf](#)
4. US Department of the Army Department of Defense (DoD) Civil Disturbance Plan, “GARDEN PLOT,” 15 February 1991 – available here:  
[USArmyCivilDisturbPlanGardenPlot\\_1991.pdf](#)

~~CONFIDENTIAL~~

# UNCLASSIFIED DEPARTMENT OF THE ARMY

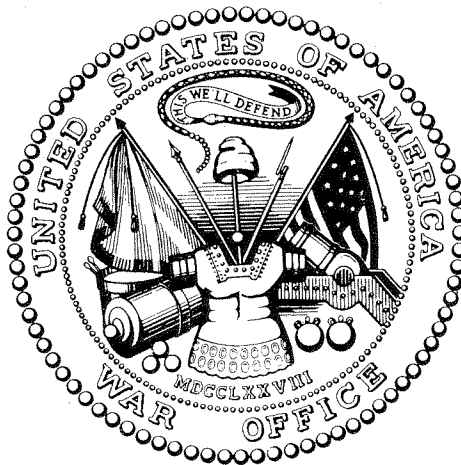

**GROUP - 3**  
Downgraded at 12 year intervals;  
Not automatically declassified.

0700523

## CIVIL DISTURBANCE

DECLASSIFIED  
DAMH-HSR-D# 8  
DATE: 10 March 88

## PLAN UNCLASSIFIED

Group - 3  
DOWNGRADED AT 3 YEAR INTERVALS  
DECLASSIFIED AFTER 12 YEARS

10 September 1968

*Not automatically declassified*

~~CONFIDENTIAL~~

*see no. 5 inside Disturbance Plans (10/68)*



Headquarters, Department of the Army  
Washington, D. C. 20310

PREFACE

1. The title of this plan is the Department of the Army Civil Disturbance Plan.
2. The nickname applicable to this plan is GARDEN PLOT. For operational consistency, Military Services, Department of Defense (DOD) components, and subordinate commands will use this nickname in civil disturbance plans.
3. The Constitution of the United States and numerous statutes provide the President with authority to intervene with Federal armed forces within the 50 states, District of Columbia, Commonwealth of Puerto Rico, US possessions and territories, or any political subdivision thereof in case of civil violence or other disturbances to:
  - a. Aid state authorities at the request of the state.
  - b. Enforce the laws of the United States in any state or territory.
  - c. Protect the civil rights of citizens within a state.
4. Authority exists to assist civil authorities with military resources short of Federal military intervention when certain necessary conditions discussed in the body of this plan are met.
5. The Secretary of the Army has been designated the Executive Agent for the Department of Defense in all matters pertaining to the planning for, deployment and employment of military resources in the event of civil disturbances. In addition, a Directorate for Civil Disturbance Planning and Operations (DCDPO), under the Chief of Staff, US Army (CofSA) has been established by the DOD Executive Agent. This Directorate plans for, coordinates and directs the employment of all designated Federal military resources for the DOD Executive Agent in civil disturbance operations and serves as the point of contact for DOD in all such matters. DOD components having cognizance over military resources are responsible for supporting the DOD Executive Agent through the DCDPO in matters pertaining to civil disturbances.

6. The provisions of this plan are applicable in the 50 states, District of Columbia, Commonwealth of Puerto Rico, US possessions, territories, or any political subdivisions thereof. The Panama Canal Zone is exempted from the provisions of this plan. Measures taken by military forces to cope with civil disturbances occurring in the Panama Canal Zone will be under the provisions of Section 35, Title 2, Canal Zone Code, 1962 (CZC35). 2

7. This plan provides guidance for development of plans to support civil disturbance operations by the Military Services, unified commands, and other DOD components.

8. This plan bears the overall classification CONFIDENTIAL because of the sensitivity of content and to protect information regarding plans for employment of United States military resources. Dissemination of information contained herein will be on a need-to-know basis. Dissemination of portions of this plan outside of DOD will be in accordance with paragraph 32, AR 380-5 and paragraph 5, AR 345-15, and applicable regulations of other Services.

9. This document contains information affecting the National Defense of the United States within the meaning of the Espionage Laws, Title 18, United States Code, Section 793. The transmission or communication of information contained herein, in any manner, to an unauthorized person is prohibited by law.

10. The proponent of this plan is the Director for Civil Disturbance Planning and Operations. Recommended changes to this plan will be submitted to the Director for Civil Disturbance Planning and Operations, ATTN: CDPO-PL-IS, Department of the Army, Washington, D. C. 20310.

11. Changes to this plan will normally be furnished in the form of complete page replacements.

12. Department of the Army Civil Disturbance Plan, 1 Feb 68, will be superseded by this plan on order. All messages and other communications pertaining to Civil Disturbance Planning and Operations which predate the date of execution of this plan, and which conflict with provisions of it, will be rescinded.

UNCLASSIFIED

UNCLASSIFIED

TABLE OF CONTENTS

<u>CONTENT</u>	<u>PAGE NUMBERS</u>
Preface	i Thru ii
Table of Contents	iii Thru vi
References	vii Thru ix
Basic DA Civil Disturbance Plan	1 Thru 10
Annex A - Task Organization, Forces, and Reaction Times	A-1 Thru A-5
Appendix 1 - Model Units	To be published
Appendix 2 - Civil Disturbance Condition (CIDCON)	To be published
Annex B - Intelligence	B-1 Thru B-8
Appendix 1 - Air Recon Request	B-1-1
Annex C - Concept of Operations	C-1 Thru C-5
Appendix 1 - Warning Order	C-1-1 Thru C-1-2
Appendix 2 - Notification of Civil Distur- bance TF Commander's Reconnaissance	C-2-1 Thru C-2-2
Appendix 3 - Personal Liaison Officer, Chief of Staff, US Army	C-3-1
Appendix 4 - Presidential Proclamation	C-4-1
Appendix 5 - Executive Order	C-5-1 Thru C-5-2
Appendix 6 - CofSA Letter of Instruction	C-6-1 Thru C-6-11
Appendix 7 - Calling Army and Air NG Units	C-7-1 Thru C-7-3
Appendix 8 - DA Message Mobilizing Reserve Units	C-8-1 Thru C-8-2
Appendix 9 - Special Instructions	C-9-1 Thru C-9-4
Annex D - Logistics	D-1 Thru D-3
Appendix 1 - Suggested Accompanying Supply and Equipment List	D-1-1 Thru D-1-4
Appendix 2 - Resupply Policy	D-2-1 Thru D-2-3
Appendix 3 - Service Support Guidance	D-3-1 Thru D-3-5
Appendix 4 - Pre-positioned Equipment and Munitions	D-4-1 Thru D-4-3

UNCLASSIFIED

TABLE OF CONTENTS (cont)

<u>CONTENT</u>	<u>PAGE NUMBERS</u>
Annex E - Personnel	E-1 Thru E-6
Appendix 1 - Medical Support	E-1-1 Thru E-1-2
Appendix 2 - Detainee Turnover Record	E-2-1 Thru E-2-2
Annex F - Information	F-1 Thru F-5
Appendix 1 - Troop Orientation	F-1-1 Thru F-1-2
Annex G - Communications-Electronics	G-1 Thru G-8
Appendix 1 - Standard City Wiring Package	G-1-1
Tab A - List of Prewired Cities	G-1-A-1 Thru G-1-A-2
Appendix 2 - Leased Communications Circuits	G-2-1 Thru G-2-2
Appendix 3 - Augmentation C-E Equipment	G-3-1 Thru G-3-3
Tab A - Items Pre-positioned and Composition of Packets	G-3-A-1
Tab B - Procedures to Obtain C-E Equipment for Active Army and Called National Guard	G-3-B-1
Tab C - Procedures to Obtain C-E Equipment State National Guard	G-3-C-1
Appendix 4 - Audio Visual	G-4-1 Thru G-4-5
Tab A - Audio-Visual Support Centers	G-4-A-1 Thru G-4-A-5
Tab B - Recommended Team Package	G-4-B-1 Thru G-4-B-2
Appendix 5 - Communications Support Require- ments (USASTRATCOM)	G-5-1 Thru G-5-3
Annex H - Command Relationships	H-1
Appendix 1 - Command Relationships for Planning	H-1-1
Appendix 2 - Command Relationships for CONUS Deployment and Redeployment	H-2-1
Appendix 3 - Command Relationships for Employment	H-3-1
Annex I - Planning	I-1 Thru I-4

4



TABLE OF CONTENTS (cont)

<u>CONTENT</u>	<u>PAGE NUMBERS</u>
Appendix 1 - Priority Objective Areas	I-1-1 Thru I-1-5
Appendix 2 - Format - Civil Disturbance Information Planning Packet	I-2-1 Thru I-2-7
Tab A - Map Symbols	I-2-A-1
Tab B - Distribution of Packets	I-2-B-1
Appendix 3 - Services, Unified Commands, USCONARC, and State Plans Distribution.	I-3-1
Appendix 4 - Operation, Concept, Support Plans	I-4-1
Annex J - Reports	J-1 Thru J-2
Appendix 1 - Joint Operational Reporting System	J-1-1
Appendix 2 - Plans Status Report	J-2-1
Appendix 3 - Task Force Movement Summary	J-3-1 Thru J-3-2
Tab A - Task Force Movement Summary	J-3-A-1
Appendix 4 - Personnel Status Report	J-4-1 Thru J-4-3
Appendix 5 - Logistic Status Report	J-5-1 Thru J-5-2
Appendix 6 - Initial Closing Report	J-6-1
Appendix 7 - Situation Report	J-7-1
Appendix 8 - Spot Intelligence Report	J-8-1 Thru J-8-2
Tab A - Abbreviated Spot Intelligence Report	J-8-A-1 Thru J-8-A-2
Appendix 9 - Daily Intelligence Summary	J-9-1 Thru J-9-2
Appendix 10 - Report of Civil Disturbance Operations Costs	J-10-1 Thru J-10-2
Tab A - Report of Civil Disturbance Operations Costs - US Army	J-10-A-1 Thru J-10-A-3
Appendix 11 - After Action Report	J-11-1 Thru J-11-2
Appendix 12 - Civil Disturbance Status Report	J-12-1
Appendix 13 - Movements Requirements and Data	J-13-1
Annex K - Providing Resources to Civil Authorities	K-1 Thru K-4
Appendix 1 - Request and Report Format	K-1-1
Annex L - Definitions	L-1 Thru L-2

TABLE OF CONTENTS (cont)

CONTENT

PAGE NUMBERS

Annex M - Memorandum of Understanding Between  
the United States Army and the United  
States Coast Guard Concerning Civil  
Disturbance Plans and Operations

M-1 Thru M-3

Annex Z - Distribution

Z-1 Thru Z-3

6

REFERENCES TO DEPARTMENT OF THE ARMY CIVIL DISTURBANCE PLAN (U)

REFERENCES:	APPLICABLE TO:
1. Title 10, Chapter 15, US Code.	Entire Plan
2. DOD Directive 3025.12, subject: Employment of Military Resources in the Event of Civil Disturbances, dated 8 Jun 68.	Entire Plan
3. Terms of Reference for DOD Steering Committee and DCDEPO.	Entire Plan
4. National Security Council Directive on Internal Security, 4 May 49.	Annex B
5. JCS Pub 1, Dictionary of United States Military Terms for Joint Usage, 1 Jan 66.	Entire Plan
6. JCS Pub 2, Unified Action Armed Forces, Nov, 59.	Entire Plan
7. JCS Pub 3, Joint Logistics and Personnel Policy and Guidance (U), 1 Mar 66.	Annex D, E
8. JCS Pub 6, Joint Operational Reporting System (U), Vols I, V, and VI.	Annex J
9. DA Civil Disturbance Information Collection Plan (ACDP) (U), 2 May 68.	Annex B
10. Army Strategic Capabilities Plan.	Annex D
11. DA Counterintelligence Research Project, Civil Disturbances CONUS, 1968.	Annex B
12. DA Counterintelligence Research Project (Compendium): Civil Disturbances and Dissidence - Cities, Organizations, and Personalities of Interest.	Annex B,D
13. DA Common Table of Allowances 50-901,	Annex D
14. DA Pamphlet 27-11, Military Assistance to Civil Authorities, 1 Dec 66.	Entire Plan
15. FM 19-15, Civil Disturbances and Disasters, Mar, 68.	Entire Plan

REFERENCES TO DEPARTMENT OF THE ARMY CIVIL DISTURBANCE PLAN (U)

REFERENCES:	APPLICABLE TO:
16. AR 1-35, Basic Policies and Principles for Interservice Support/SECNAV INST 4000.20-27, 2 Feb 68, with DOD Directive 4000.19 as an appendix.	Annex D
17. AR 40-2, Army Medical Treatment Facilities General Administration, 17 Jun 65, w/changes 1-4.	Annex E
18. AR 40-3, Medical Dental, and Veterinary Care, 26 Mar 62, w/changes 1-15.	Annex E
19. AR 40-121, Uniformed Services Health Benefits Program, SECNAV INST 6320.8C/ AFR 168-9/PHS GEN CIR NO 6/CG COMDTINST 6320.2A, 13 Feb 67.	Annex E, App. 1
20. AR 40-535, Worldwide Aeromedical Evacuation, AFR 164-1/OPNAVINST 4630.9B/MCO P4630.9, 15 May 64.	Annex E
21. AR 108-5, Still and Motion Picture Photography, 11 Jun 65.	Annex G, App. 4
22. AR 108-30, Operation of Army Audio-visual Communications Centers, 11 Jun 65.	Annex G, App. 4
23. AR 108-40, Television, 29 May 67.	Annex G, App. 4
24. AR 135-20, Release from Active Duty Reserve Components.	Annex C, E
25. AR 135-300, Mobilization of Army National Guard of the United States and Army Reserve Units, 5 Mar 65.	Annex C, E
26. AR 330-12, Effective Date of Change of Strength Accountability (EDCSA), 25 Jan 67.	Annex E
27. AR 335-60, Morning Report, 10 Apr 67, w/change 1.	Annex E
28. AR 360-5, Public Information - General Policies, 27 Sep 67.	Annex F

REFERENCES TO DEPARTMENT OF THE ARMY CIVIL DISTURBANCE PLAN (U)

REFERENCES:	APPLICABLE TO:
29. AR 360-31, Command Information Program - General Provisions, 20 Apr 64, w/changes 1-4.	Annex F
30. AR 381-115, Military Intelligence Counter- intelligence Investigative Agencies/AFR 124-11: Agreement to Delimit Investigative Duties of the Office of Special Investigations/OPNAV INSTR 5520.7A, 15 Mar 56.	Annex B
31. AR 500-50, Emergency Employment of Army Resources, Civil Disturbances, 25 Feb 64, w/change 1.	Entire Plan
32. AR 525-10, Department of the Army Command and Control System (DACCS) (U), 21 Feb 67, w/changes 1-4.	Annex J, App. 12
33. AR 525-15, Operational Reports - Lessons Learned, 26 Jan 65.	Annex J, App. 11
34. AR 600-10, The Army Casualty System, 30 Jun 66, w/change 1.	Annex E
35. Army Subject Schedule 19-6, Control of Civil Disturbances, 21 February 1968.	Basic Plan
36. Memorandum of Understanding between the US Army and the US Coast Guard concerning Civil Disturbance Plans and Operations, 30 Aug 68.	Entire Plan

Faint vertical text on the left edge of the page.

Faint horizontal text at the top center of the page.



Headquarters, Department of the Army  
Washington, D. C. 20310  
10 September 1968

DEPARTMENT OF THE ARMY CIVIL DISTURBANCE PLAN (U)

References: Pages vii thru ix

Time Zone: GMT (ZULU)

Task Organization: Annex A, Task Organization, Forces and  
Reaction Times

1. (C) SITUATION

a. General. The primary responsibility for protection of life and property and the maintenance of law and order within the territorial jurisdiction of any state, the District of Columbia, Commonwealth of Puerto Rico, US possessions and territories is vested in the local and state governments. Civil disturbances beyond the capability of local and state governments to control with available resources may occur which will result in requests for Federal assistance. The employment of DOD military resources for assistance to civil authorities in controlling civil disturbances will normally be authorized by a Presidential Directive or an Executive Order directing the Secretary of Defense to restore law and order in a specific state or locality. Exceptions to this condition will be limited to:

- (1) Sudden and unexpected civil disturbances or other emergencies endangering life or Federal property, disrupting the normal processes of government which require that immediate military action be taken to protect life or Federal property or to prevent disruption of Federal activities.
- (2) Provision of military resources in response to requests received by local military commanders from civil authorities for use in connection with civil disturbances (Annex K, Providing Assistance to Civil Authorities).
- (3) Protection of Federal property and functions.

b. Authority. DOD Directive 3025.12 designates the Secretary of the Army as the Executive Agent for DOD in all matters pertaining to the planning for and employment of Federal military resources in the event of civil disturbances in the 50 states, District of Columbia, Commonwealth of Puerto Rico, US possessions

~~UNCLASSIFIED~~

~~CONFIDENTIAL~~

and territories, or any political subdivision thereof. The Executive Agent (or the Under Secretary of the Army, as his designee) exercises direction through the Chief of Staff, US Army (CofSA) in the Continental United States (CONUS) and through commanders designated by the JCS outside the CONUS.

12

c. Dissident Elements. Annex B, Intelligence.

d. Federal and State Forces:

(1) Department of Justice.

(a) The Attorney General designates a senior civilian representative(s) in the event of a civil disturbance(s).

(b) The Attorney General is advised prior to the pre-positioning of ground force units.

(c) Provides advice and support as required to carry out the provisions of the Executive Order(s).

(d) Receives and coordinates preliminary requests from states for intervention with Federal armed forces in cases of civil disturbances.

(2) State Adjutants General. Prepare and coordinate state civil disturbance plans. In the CONUS, coordinate plans with Army Area commanders; outside of CONUS coordinate plans with commanders of unified commands concerned.

(3) Joint Chiefs of Staff:

(a) Establish procedures that will promptly transfer military resources that are assigned to unified and specified commands to the Military Departments for civil disturbance operations in CONUS or to unified commands for such operations outside of CONUS, as directed by the DOD Executive Agent and consistent with defense priorities.

(b) Maintain an appropriate strategic reserve for world-wide employment and contingency operations.

UNCLASSIFIED

~~CONFIDENTIAL~~



~~CONFIDENTIAL~~

UNCLASSIFIED

13

(c) Insure that directives are issued to commanders of unified commands concerning civil disturbance matters outside of CONUS for the employment of Federal military resources in accordance with direction and guidance provided by the DOD Executive Agent.

(4) US Coast Guard. Provides coastal and inland water patrolling forces and logistics in support of civil disturbance operations as directed.

e. Assumptions:

- (1) Simultaneous civil disturbances requiring Federal intervention may occur in any of the 50 states, District of Columbia, Commonwealth of Puerto Rico, US possessions and territories.
- (2) Disturbances requiring Federal intervention will occur simultaneously in up to 25 objective areas throughout the CONUS necessitating the employment in each objective area of up to five 2000-man brigades plus supporting troops, with the exception of Washington, D. C., when forces totaling 30,000 troops may be employed.
- (3) In response to a request from a state legislature, or from the governor if the legislature cannot be convened, the use of Federal military resources will be directed to quell civil disturbances when it is determined by the President that local and state resources are incapable of coping with the disturbances. Army and Air National Guard units may be called into active Federal service and Reserve units of all Services may be ordered to active duty as required when the decision is made to commit Federal forces.

2. (U) MISSION

When directed by the President, the Secretary of the Army, the DOD Executive Agent, through appropriate military commanders, will employ Federal forces to assist local authorities in the restoration and maintenance of law and order in the 50 states, the District of Columbia, the Commonwealth of Puerto Rico, and US possessions and territories or any political subdivision thereof.

~~CONFIDENTIAL~~

UNCLASSIFIED

~~UNCLASSIFIED~~

~~CONFIDENTIAL~~

3. (C) EXECUTION

a. Concept of Operations. Civil disturbance operations will be conducted in three phases:

- (1) Phase I - Deployment.
- (2) Phase II - Employment.
- (3) Phase III - Redeployment.

b. When the President directs that Federal troops be employed in civil disturbance operations, the DOD Executive Agent directs, through the CofSA, the timely deployment and employment of Federal military resources necessary to restore law and order in the objective area(s). Deployment of forces may be for the purpose of pre-positioning military resources. Upon completion of assigned mission(s), the CofSA directs redeployment of Federal military resources (Annex C, Concept of Operations). For disturbances outside the CONUS, see 3f below.

c. Defense Communications Agency (DCA). Provides DCA support for civil disturbance operations.

d. Defense Intelligence Agency (DIA). Provides intelligence support in DA Civil Disturbance Information Collection Plan (ACDP) (U), 2 May 1968.

e. Defense Supply Agency (DSA). Provides DSA support for civil disturbance operations.

f. Unified Commands (outside of CONUS):

- (1) Organize, train, support, and maintain in readiness designated forces for civil disturbance operations within assigned areas of responsibility consistent with defense priorities. Where appropriate, Reserve component units designated as potentially available in High Priority objective areas will be included in operations plans.
- (2) Deploy, employ, redeploy, and support available civil disturbance forces including National Guard and/or Reserve forces in civil disturbance operations.
- (3) Designate task force commander(s).

~~UNCLASSIFIED~~

~~CONFIDENTIAL~~

~~CONFIDENTIAL~~

UNCLASSIFIED  
CONFIDENTIAL

0  
15

- (4) Prepare information planning packets for all priority objective areas; operation plans, including support plans, for High Priority objective areas; and concept plans for Intermediate Priority objective areas. Objective areas and priorities for objective areas will be determined by commanders of unified commands concerned.
- (5) Provide for the employment of National Guard and Reserve advisors as required and authorized.
- (6) Make known by dual addressee communication (i.e. to JCS and DOD Executive Agent) resources required for civil disturbance operations in excess of those available within their commands.

g. US Strike Command (USSTRICOM): Provides military resources to commanders of unified commands and Military Departments as directed.

h. US Continental Army Command/US Army Forces Strike Command (USCONARC/USARSTRIKE) in CONUS:

- (1) Organizes, trains, and maintains in readiness assigned Army and designated REFORGER forces for civil disturbance operations. Reserve component units designated as potentially available in High Priority objective areas will be included in operation plans.
- (2) Nominates task force commanders subject to approval by the CofSA.
- (3) Nominates units to be assigned to task forces for civil disturbance operations.
- (4) Deploys and redeploys civil disturbance ground forces as directed by the CofSA. Passes operational control of forces during the Employment Phase (Phase II) to CofSA.
- (5) Prepares civil disturbance information planning packets for all priority objective areas.
- (6) Prepares operations plans, including support plans, for the employment of active military forces in the 25 High Priority objective areas (appendix 1, annex I).

UNCLASSIFIED

~~CONFIDENTIAL~~

UNCLASSIFIED

16

- (7) Prepares concept plans for Intermediate Priority objective areas (appendix 1, annex I).
  - (8) Coordinates with DCDPO for required air and/or surface transportation for all Federal military ground forces committed to civil disturbance operations.
  - (9) Provides for the logistic support of all active military ground forces in the objective areas.
  - (10) Provides for the employment of CONUS Army National Guard and USAR advisors as required and authorized.
  - (11) Insures that training programs and doctrine for civil disturbances are made available to Military Services and unified commands concerned.
- i. US Army Intelligence Command (USAINTC):
    - (1) Monitors areas of imminent and actual unrest in CONUS and disseminates information to DA/CDPO and commanders concerned.
    - (2) Provides support to the designated task force commander(s) in CONUS prior to and during periods of increased tension.
  - j. US Army Strategic Communications Command (USASTRATCOM):
    - (1) Provides communications support as required by the DOD Executive Agent for civil disturbance operations.
    - (2) Organizes, trains, and maintains in readiness 25 USASTRATCOM detachments for use in civil disturbance operations.
  - k. US Army Materiel Command (USAMC). Provides wholesale logistic resupply support to active military forces committed to civil disturbance operations as requested by CGUSCONARC.
  - l. Military Traffic Management and Terminal Service (MTMTS). Provides for commercial surface transportation in support of civil disturbance operations as requested by DCDPO.
  - m. US Army Map Service (USAMS). Provides map services in support of civil disturbance planning and operations.

UNCLASSIFIED ~~CONFIDENTIAL~~

17

n. Task Force Commanders in CONUS:

- (1) Move to objective area(s) as directed by CofSA.
- (2) Comply with the Letter of Instruction from CofSA (appendix 6, annex C) for restoration of law and order in the objective area.
- (3) Establish liaison, through CONUS Army commanders and state adjutants general, with state and municipal civil authorities, and Reserve component unit commanders in the vicinity of the objective areas as required.
- (4) Assume operational control of attached active military ground forces in the objective area on order of CofSA.
- (5) Maintain liaison with the senior civilian representative of the Attorney General, the representative of the Department of Justice (DOJ), and other Federal Government representatives and state and municipal officials in the objective area as appropriate.
- (6) Recommend, in coordination with the senior civilian representative of the Attorney General and after consultations with state and municipal authorities and law enforcement agencies the following: the date and time National Guard forces should revert to state control; the disposition of mobilized Reserves; the date and time Federal troops should be withdrawn, the sequence of redeployment of such forces; and the time task force headquarters should pass operational control of forces to CGUSCONARC for movement to home stations.

o. Other Army Commands. Provide support for civil disturbance operations as required.

p. Department of the Navy (DN):

- (1) Designates and provides military resources of the USN and USMC required by the DOD Executive Agent and consistent with defense priorities, to include organized and trained ground forces to the CofSA for employment in civil disturbance operations.

(2) Consistent with defense priorities, makes airlift resources available to the Secretary of the Air Force as requested.

(3) Orders required Naval and Marine Corps Reserve components to active duty.

18

q. Department of the Air Force (DAF):

(1) Provides military resources of the United States Air Force (USAF) consistent with defense priorities, as required by the DOD Executive Agent to carry out the provisions of the Presidential Executive Order or other appropriate authority, to include designating specific units or members of the Air National Guard to be called into active Federal service; and designating and ordering to active duty units of the Air Force Reserve.

(2) Exercises, for the DOD Executive Agent, coordinating authority over and direction of DOD provided military and commercial obligated airlift resources used to fulfill civil disturbance airlift requirements.

(3) Provides airlift for civil disturbance forces for deployment and redeployment, supply and resupply, aerial reconnaissance, special operations, air weather support, and aeromedical evacuation for military forces as required.

r. Coordinating Instructions:

(1) This plan is effective for planning on receipt and for execution on order.

(2) This plan provides guidance and direction for participating Military Services and DOD components in all civil disturbance matters.

(3) To assist agencies responsible, plans will include measures to prevent the capture of arms and ammunition. This will include the capture, destruction, and compromise of nuclear weapons and components.

(4) Coordination is authorized between Military Services, DOD agencies, major Army commands involved, CONUS armies, Reserve components, US Coast Guard, Eastern and Western Sea Frontiers, Naval Districts, Air

~~CONFIDENTIAL~~

UNCLASSIFIED

19

Force major commands and Air Force installations. Coordination with civilian planning authorities, with the exception of DOD agencies, will be as directed by CGUSCONARC in CONUS and by unified commanders outside of CONUS.

- (5) Plans will be prepared, reviewed, and distributed in accordance with instructions contained in annex I, this plan.
  - (6) Commands charged with Strategic Army Forces (STRAF) missions will prepare plans for extricating forces from civil disturbance operations.
  - (7) Civil disturbance operations reports will be submitted in accordance with annex J.
  - (8) All messages/correspondence pertaining to civil disturbance plans and operations will include the nickname GARDEN PLOT.
  - (9) Communications for the DOD Executive Agent or CofSA in civil disturbance matters will be addressed to CDPO-CDCC. Oral instructions given during GARDEN PLOT operations will be confirmed, as time permits, by written communication.
  - (10) Employment of ground forces of two or more Military Services will be in accordance with subsections 1 and 2, section 2, chapter III, JCS Pub 2.
4. (U) ADMINISTRATION AND LOGISTICS
- a. Logistics - Annex D.
  - b. Personnel - Annex E.
  - c. Information - Annex F.
5. (U) COMMAND AND SIGNAL
- a. Command:
    - (1) Command Relationships - Annex H.
    - (2) Command Posts (Pre-wired Cities) - Annex G.
  - b. Signal - Annex G.

UNCLASSIFIED

~~CONFIDENTIAL~~

- Annexes: A - Task Organization, Forces and Reaction Times  
B - Intelligence  
C - Concept of Operations  
D - Logistics  
E - Personnel  
F - Information  
G - Communications-Electronics  
H - Command Relationships  
I - Planning  
J - Reports  
K - Providing Assistance to Civil Authorities  
L - Definitions  
M - Memorandum of Understanding  
Z - Distribution

20

OFFICIAL:

*Mather*  
MATHER  
Director CDPO



ANNEX A (TASK ORGANIZATION, FORCES, AND REACTION TIMES) TO  
DEPARTMENT OF THE ARMY CIVIL DISTURBANCE PLAN (U)

21

1. (U) TASK ORGANIZATION

Department of Defense

<u>Agency</u>	<u>Command Post</u>
Department of the Army	The Pentagon, Washington, DC
Department of the Navy	The Pentagon, Washington, DC
Department of the Air Force	The Pentagon, Washington, DC
Defense Supply Agency	Cameron Station, Alexandria, VA

Joint Chiefs of Staff

<u>Agency</u>	<u>Command Post</u>
Defense Intelligence Agency	The Pentagon, Washington, DC
Defense Communications Agency	8th St. and S. Courthouse Rd., Arlington, VA

Unified Commands

<u>Agency</u>	<u>Command Post</u>
Alaskan Command	Elmendorf AFB, Anchorage, AL
Atlantic Command	US Naval Base, Norfolk, VA
Pacific Command	Camp HM Smith, HI
Southern Command	Quarry Heights, CZ
Strike Command	McDill AFB, Tampa, FL

Department of the Army

<u>Agency</u>	<u>Command Post</u>
USCONARC	Fort Monroe, VA
USARSTRIKE	Fort Monroe, VA
USAMC	Gravelly Point, Washington, DC
USAINTC	Fort Holabird, MD
USASTRATCOM	Fort Huachuca, AZ
MTMIS	Washington, DC
DA Liaison Team (when appointed)	(With Task Force Commander)
Task Force Commander (when appointed)	(appendix I, annex G, or when determined)

ANNEX A (TASK ORGANIZATION, FORCES, AND REACTION TIMES) TO  
DEPARTMENT OF THE ARMY CIVIL DISTURBANCE PLAN (U)

22

Department of the Navy

<u>Agency</u>	<u>Command Post</u>
CNO	The Pentagon, Washington, DC
CMC	Navy Annex, Washington, DC
East Sea Fron	90 Church St., New York, NY
West Sea Fron	US Naval Station, TI, San Francisco, CA

Department of the Air Force

<u>Agency</u>	<u>Command Post</u>
MAC	Scott AFB, IL
TAC	Langley AFB, VA
AFRES	Robins, AFB, GA

US Coast Guard

<u>Agency</u>	<u>Command Post</u>
Comdt US Coast Guard	1300 E St., NW, Washington, DC

2. (C) FORCES

a. Twenty-six\* civil disturbance task force headquarters will be designated and maintained in readiness to insure timely and effective response in support of the DA Civil Disturbance Plan. Task force headquarters will be provided as follows:

<u>HEADQUARTERS/COMMAND</u>	<u>ORIGIN OF TF</u>	<u>NUMBER PROVIDED</u>
CofSA	DA HQ	1**
CINCARSTRIKE	XVIII ABN CORPS	1
	III CORPS	1
	ARSTRIKE DIVISIONS	3
CGUSCONARC	TFI	1***
	OTHER CONUS FORCES	<u>19</u>
	TOTAL	26*

\*Two of the 26 TF Headquarters will be employed in the Washington, DC area.

\*\*Overall responsibility in the Washington, DC objective area.

\*\*\*Provided by HQ MDW for control of initial forces employed in the Washington, DC area.

# UNCLASSIFIED

## ANNEX A (TASK ORGANIZATION, FORCES, AND REACTION TIMES) TO DEPARTMENT OF THE ARMY CIVIL DISTURBANCE PLAN (U)

23

b. TOE combat and combat support forces will be organized into company, battalion, and brigade forces to permit flexibility of employment.

c. The CGUSCONARC will insure that designated CONUS Armies are prepared to provide forces as follows:

<u>TYPE FORCE</u>	<u>APPROXIMATE STRENGTH</u>
(1) Company Immediate Ready Elements (IRE)	150-200
(2) Battalions	600-800*
(3) Brigade Forces	1800-2600*

d. Force Requirements:

- (1) CGUSCONARC will maintain a total of 17 regular brigades.
- (2) The CMC will maintain a total of four regular regiments.

e. A division task force will consist of two or more brigade/ regiment forces plus control and support elements.

f. A brigade task force will normally be commanded by a major general. A division-size force will normally be commanded by a lieutenant general.

g. CGUSCONARC will maintain quick reaction forces (QRF) of brigade size. One QRF will be oriented for the Eastern United States and one for the Western United States. Reaction times for each element of the QRF as indicated will not be exceeded.

Company (IRE)	6 Hour
Battalion (-)	12 Hour
Brigade (-)	24 Hour

h. Task force headquarters will include as a minimum the following representation:

\* Battalion and brigade strengths may include a command and control headquarters and small support element.

ANNEX A (TASK ORGANIZATION, FORCES, AND REACTION TIMES) TO  
DEPARTMENT OF THE ARMY CIVIL DISTURBANCE PLAN (U)

- (1) Engineer (Real Estate)
- (2) Information Officer
- (3) Judge Advocate
- (4) Military Intelligence Specialists (augmentation)
- (5) Provost Marshal
- (6) Signal Officer
- (7) Surgeon
- (8) USAF Air Liaison Officer (ALO)

24

i. CGUSCONARC will provide Army aviation support as follows:

- (1) Helicopter lift for one 200-man IRE company per CONUS Army.
- (2) Aircraft with riot control agent disperser and loudspeaker capability.
- (3) Command and control helicopters.
- (4) Helicopter medical evacuation within the objective areas.
- (5) Aerial reconnaissance support.

j. CGUSCONARC will insure that the following type combat support and combat service support forces are suitably tailored to support operations plans for High Priority objective areas:

- (1) Aviation
- (2) Logistical control headquarters
- (3) Maintenance
- (4) Medical
- (5) Military Police and Criminal Investigative support.
- (6) Ordnance (Ammo)

~~CONFIDENTIAL~~

UNCLASSIFIED

ANNEX A (TASK ORGANIZATION, FORCES, AND REACTION TIMES) TO  
DEPARTMENT OF THE ARMY CIVIL DISTURBANCE PLAN (U)

25

- (7) Psychological Operations
- (8) Signal
- (9) Supply and service
- (10) Transportation

3. (U) ADDITIONAL ACTIVE GROUND FORCES

Additional active ground forces stationed in the vicinity of objective areas and designated for civil disturbance operations, may be employed as directed by the CofSA.

4. (C) FORCE SUPPORT

For planning purposes, the minimum force to be supported in any single objective area is 2,000, the maximum to be supported is 10,000 plus supporting troops. An exception to the foregoing is that the maximum troop strength to be supported in the Washington, DC area is 30,000.

A-5

~~CONFIDENTIAL~~ UNCLASSIFIED

UNCLASSIFIED

0

C

C

APPENDIX 1 (MODEL UNITS) TO ANNEX A (TASK ORGANIZATION,  
FORCES, AND REACTION TIMES) TO DEPARTMENT OF THE ARMY  
CIVIL DISTURBANCE PLAN (U)

27

TO BE PUBLISHED

A-1-1

Faint, illegible text at the top of the page, possibly a header or title.





29

APPENDIX 2 (CIVIL DISTURBANCE CONDITION (CIDCON)) TO  
ANNEX A (TASK ORGANIZATION, FORCES, AND REACTION TIMES) TO  
DEPARTMENT OF THE ARMY CIVIL DISTURBANCE PLAN (U)

TO BE PUBLISHED



31

ANNEX B (INTELLIGENCE) TO DEPARTMENT OF THE ARMY CIVIL DISTURBANCE PLAN (U)

References:

- a. Civil Disturbance Information Planning Packets, including pertinent maps.
- b. National Security Council Directive on Internal Security, 4 May 1949.
- c. DA Counterintelligence Research Project (Compendium): Civil Disturbances and Dissidence - Cities, Organizations, and Personalities of Interest.
- d. DA Civil Disturbance Information Collection Plan.
- e. AR 381-115, Counterintelligence Investigative Agencies, 16 Mar 56.

1. (FOUO) SITUATION

a. General.

- (1) Civil disturbances which are beyond the control of municipal or state authorities may occur at any time. Dissatisfaction with the environmental conditions contributing to racial unrest and civil disturbances and dissatisfaction with national policy as manifested in the anti-draft and anti-Vietnam demonstrations are recognized factors within the political and social structure. As such, they might provide a preconditioned base for a steadily deteriorating situation leading to demonstrations and violent attacks upon the social order. The consistency and intensity of these pre-conditions could lead in time to a situation of insurgency should external subversive forces develop successful control of the situation. Federal military intervention may be required to preserve life and property and maintain normal processes of governments.
- (2) Analysis of civil disturbances. DA Counterintelligence Research Project (counterintelligence estimate): Civil Disturbances, CONUS (published quarterly).
- (3) Urban areas. In assessing the probabilities of civil disturbances occurring in urban areas, the following should be considered:

B-1

ANNEX B (INTELLIGENCE) TO DEPARTMENT OF THE ARMY CIVIL DISTURBANCE PLAN (U)

32

- (a) Population by race.
- (b) Population of the "core city" of the urban area; percentage and distribution of the minorities population.
- (c) Presence of large "blue collar" neighborhoods, as reflected by the industrial payrolls and industrial concentrations.
- (d) Presence of poor economic and sociological conditions, and their reflections in crime rates.
- (e) Unemployment rate in the area, and sections of concentrated unemployment.
- (f) Presence and degree of activity of militant racial, leftist (anti-war and anti-draft), and extreme right-wing groups, and an assessment of the capabilities of these groups to provoke disturbances.
- (g) History of civil disturbances in the area.
- (h) Assessment of known and probable demonstrations.
- (i) Existence of wide-spread sense of injustice and real or imagined lack of means of redress.
- (j) Caching of arms or explosives; other preparations for disturbances.

b. Dissident Elements. Reference c.

2. (C) ESSENTIAL ELEMENTS OF INFORMATION (EEI) AND OTHER INTELLIGENCE REQUIREMENTS (OIR)

a. Plans, operations, deployment, tactics, techniques, and capabilities of individuals, groups or organizations whose efforts are to reduce US military capabilities through espionage, sabotage, disaffection, subversion, treason, propaganda, and other disruptive operations.

b. Patterns, techniques, and capabilities of subversive elements in cover and deception efforts in civil disturbances.

ANNEX B (INTELLIGENCE) TO DEPARTMENT OF THE ARMY CIVIL DISTURBANCE PLAN (U)

33

c. Civil disturbances which involve CONUS military installations or personnel.

d. Thefts from any source of significant quantities of weapons and ammunition.

e. Unusual or suspect sales of weapons and ammunition.

f. Strikes, civil disturbances and labor disturbances which affect military installations or other strikes or labor and civil disturbances of sufficient magnitude to indicate a probable employment of Federal troops to preserve or restore order.

g. Information concerning anticipated opposition to military intervention, to include courses of action, methods and capabilities, weapons, and support.

h. Reaction to changes of Federal, state or municipal laws, court decisions, referendums, amendments, executive orders, or other directives which affect minority groups.

i. Cause of civil disturbances and names of instigators and group participants.

j. Propaganda themes and media used by agitators.

k. Indicators of potential violence:

- (1) High unemployment rate among minority groups.
- (2) Increased crime rates among minority groups.
- (3) Protests arising from income disparities between minority and majority groups.
- (4) Declining rapport between local officials and minority groups.
- (5) Migrations of large numbers of minority groups.
- (6) Protests by minority groups to such conditions as slum conditions, segregation in housing and schools, lack of jobs, lack of recreational facilities, police brutality, and local overpricing practices.

~~UNCLASSIFIED~~ ~~CONFIDENTIAL~~

ANNEX B (INTELLIGENCE) TO DEPARTMENT OF THE ARMY CIVIL DISTURBANCE  
PLAN (U)

34

1. Indicators of imminent violence:

- (1) Presence of militant agitators.
- (2) Increase in thefts and sales of weapons and ammunition.
- (3) Increase in efforts of agitators and increased signs of their efforts to instigate violence.
- (4) Increase of incidents such as window breaking, false fire alarms, thefts, and other harassments.
- (5) Reports and rumors of planned violence.

m. Specifics during disturbances:

- (1) Geographic outlines of areas in which actual civil disturbances are occurring.
- (2) Description of actual or potential areas of disturbances (i.e. high-rise apartments, tenements, business districts, separate homes, parklands).
- (3) Nature of disturbances including fire, looting, arson, and numbers and types of people involved (i.e. juveniles, Negroes, Puerto Ricans).
- (4) Identification of agitators or motivating elements.
- (5) Trends.
- (6) Numbers of persons arrested and information of known militant personnel.
- (7) Forces committed (i.e. police, civil police reinforcements, state police, NG, or other).
  - (a) Action taken by police.
  - (b) Types of forces used to break up the disturbance.
  - (c) Curfews that are placed in effect.

B-4

~~UNCLASSIFIED~~

~~CONFIDENTIAL~~

~~CONFIDENTIAL~~

UNCLASSIFIED

35

ANNEX B (INTELLIGENCE) TO DEPARTMENT OF THE ARMY CIVIL DISTURBANCE PLAN (U)

3. (C) ORDERS FOR INFORMATION AND SUPPORT

a. Task force commanders will not attempt penetration or conduct other intelligence collection missions which might violate reference e above, either before or during disturbances.

b. Ground reconnaissance will be performed with discretion before disturbances.

c. CGUSCONARC will provide intelligence production personnel support to task force commanders as required to include provision of intelligence staff personnel, intelligence analysts, order of battle specialists and interrogators as required.

d. CGUSAINTC select and report Intelligence Operations Center locations in each of the High Priority objective areas. Address to this headquarters (ATTN: DCSPER) requests for personnel required to man operation centers in excess of USAINTC personnel resources.

4. (C) MISCELLANEOUS

a. Maps and aerial photos.

(1) Maps required and available, less those under DA control, at US Army Map Service will be distributed as directed by CGUSCONARC.

(2) Requests for aerial photos, see 4e below.

b. Counterintelligence.

(1) Security classification guidelines.

(a) The following information is CONFIDENTIAL regarding civil disturbance planning and operations:

1. Military plans and task forces organization.
2. Military intelligence overall roles and missions.

(b) The following information is FOR OFFICIAL USE ONLY:

B-5

~~CONFIDENTIAL~~

UNCLASSIFIED

UNCLASSIFIED

~~CONFIDENTIAL~~

ANNEX B (INTELLIGENCE) TO DEPARTMENT OF THE ARMY CIVIL DISTURBANCE  
PLAN (U)

36

1. Local government and Federal non-DOD agency civil disturbances plans and activities (unless otherwise classified by those agencies).
2. The fact that DOD and non-DOD Federal and local agencies are collaborating on overall civil disturbance planning.
3. Proposed objective area command post locations for task forces.
4. Locations of airfields, assembly areas, and supply facilities planned for military use in conjunction with civil disturbance operations.

(2) Release Authority.

(a) General.

1. DA Civil Disturbance Plan, DA CD Information Collection Plan, and DA CD Planning Packets are authorized for release to agencies indicated on distribution lists.
2. Distribution of civil disturbance documents prepared by other than DA agencies will be only as specified by preparing agencies.
3. DA CD planning documents containing information directly attributable to FBI sources will not be released outside DOD or DOJ without FBI approval.

(b) Release to city officials. Active Army FOR OFFICIAL USE ONLY CD planning data may be released to city officials of priority urban areas as follows:

1. In accordance with AR 345-15.
2. As authorized by CONUS Army or task force commanders.

B-6

UNCLASSIFIED ~~CONFIDENTIAL~~



ANNEX B (INTELLIGENCE) TO DEPARTMENT OF THE ARMY CIVIL DISTURBANCE PLAN (U)

37

3. On a need-to-know basis on particular urban area under consideration.
4. With notification to city officials of sensitive nature of data and need to treat data accordingly.
5. As required to explain magnitude and types of coordination and cooperation required from city officials as well as necessary DA reconnaissance, liaison and other preparations for commitment of Federal forces.

(c) Emergency release of classified information. Task force commanders may waive the release provisions of this plan and AR 380-5 which interfere with or impede the conduct of military operations.

- (3) Downgrading. On implementation of this OPLAN, so much of the information listed in b(1)(a)1. above as pertains to the specific objective area where Federal forces are being employed is regraded FOR OFFICIAL USE ONLY; information in b(1)(a)2. remains CONFIDENTIAL; information in b(1)(b)1. remains FOR OFFICIAL USE ONLY; and information in b(1)(b)2., 3., and 4. becomes UNCLASSIFIED.

c. Intelligence Contingency Funds (ICF). Expenditure of ICF by task force commanders in support of civil disturbance operations will be with approval by this headquarters.

d. Liaison.

- (1) The USAINTC representative in the objective area is the point of contact for intelligence liaison with local government agencies and other Federal agencies.
- (2) Intelligence liaison between active military forces and civilian agencies will be conducted as authorized by this headquarters or the task force commander.

**UNCLASSIFIED**

~~**CONFIDENTIAL**~~

ANNEX B (INTELLIGENCE) TO DEPARTMENT OF THE ARMY CIVIL DISTURBANCE  
PLAN (U)

38

e. Reports and requests.

(1) Annex J, Reports.

(2) Requests for aerial reconnaissance will be forwarded to DCDPO, ATTN: CDPO-CDCC for approval and forwarding to CDAC (Appendix 1, Air Recon Request Format).

Appendix: 1 - Air Recon Request

B-8

**UNCLASSIFIED** ~~**CONFIDENTIAL**~~

~~FOR OFFICIAL USE ONLY~~

APPENDIX 1 (AIR RECON REQUEST) TO ANNEX B (INTELLIGENCE) TO  
DEPARTMENT OF THE ARMY CIVIL DISTURBANCE PLAN (U)

39

AIR RECONNAISSANCE REQUEST

1. FROM (Requesting Agency)
2. DATE/TIME
3. TO (Agency receiving request)
4. TYPE OF RECONNAISSANCE (Photo, visual, other)
5. MAP SERIES AND SHEET NO
6. DESCRIPTION OF TARGET AND MAP REFERENCES
7. OBJECTIVE OF REQUEST AND RESULTS DESIRED
8. PHOTO SCALE OR LIMITS ACCEPTABLE
9. NO OF PRINTS, PLOTS, MOSAICS AND/OR REPORTS REQUIRED
10. DELIVERY ADDRESS, DATE AND TIME
11. LATEST ACCEPTABLE TIME AND DATE
12. SPECIAL INSTRUCTIONS: TOT OR OTHER SPECIAL INSTRUCTIONS

B-1-1

~~FOR OFFICIAL USE ONLY~~



ANNEX C (CONCEPT OF OPERATIONS) TO DEPARTMENT OF THE ARMY CIVIL  
DISTURBANCE PLAN (U)

1. (C) GENERAL

41

a. Singular or multiple civil disturbances with which municipal, state, and/or territorial forces are incapable of coping may develop within the 50 states, District of Columbia, Commonwealth of Puerto Rico, US territories and/or possessions. In either event, it is anticipated that Federal assistance will be directed by the President. When Federal intervention is directed, required military resources of unified and specified commands will be transferred by the JCS to their respective Military Departments. Concurrently with, or following the direction to use active Federal resources in civil disturbance operations, designated National Guard units may be called into active Federal service and Reserve units may be ordered to active duty. In CONUS, designated active military ground forces employed will be under the operational control of the CofSA. When REFORGER units are employed, USCINCEUR will be notified. In civil disturbances outside of CONUS, the DOD Executive Agent will exercise direction of all forces employed in civil disturbance operations through the commanders designated by the commanders of unified commands keeping the JCS informed of all actions pertaining thereto. The probable order of employment of forces available in civil disturbances will be:

- (1) Local and state police.
- (2) State National Guard.
- (3) Federal military forces to include called Army and Air National Guard.
- (4) Reserve units of the Services ordered to active duty.

b. The situation existing at the time of the disturbances may require that the above-listed order of employment of forces be altered.

c. When Federal troops are employed in an objective area of CONUS, an Active Army general officer will be designated the task force commander and will be delegated operational control of all attached military ground forces committed in that operation. In objective areas outside of the CONUS, the control of military forces will be as directed by unified commanders involved.

d. This plan applies to and provides the basis for the preparation, deployment, employment and redeployment of designated

ANNEX C (CONCEPT OF OPERATIONS) TO DEPARTMENT OF THE ARMY CIVIL  
DISTURBANCE PLAN (U)

42

forces of Military Services, including called National Guard and Reserves ordered to active duty, for employment in civil disturbance operations in the 50 states, District of Columbia, Commonwealth of Puerto Rico, US possessions, and territories as the President may direct.

e. When appropriate and practical, military ground forces employed in civil disturbance operations will employ tailored organizations and minimum essential equipment (annex A, Appendix 1 - Model Units).

f. Called National Guard units will normally be employed in state(s) of origin and Reserve units of all Services ordered to active duty will normally be employed in the vicinity of the unit's home location, although movement and employment of these units as required is authorized.

g. Ground elements of Federal military forces, including selected Reserve units of all Services ordered to active duty and called Army and Air National Guard units, will be deployed, employed and redeployed as directed by the CofSA. When directed, operational control of all ground forces provided by the Army, Navy, and Marine Corps to include those forces released by the JCS for civil disturbance operations in CONUS will be passed to CGUSCONARC for movement to and from objective areas. Ground forces provided by the Air Force will be under the direction of the CofSA for movement to and from the objective areas. Upon completion of redeployment, forces will be transferred to the Military Departments as directed by CofSA.

2. (C) OPERATIONS

a. The President directs Federal intervention in civil disturbances. The Secretary of the Army as DOD Executive Agent directs, through the CofSA in CONUS and through designated commanders of the unified commands outside of CONUS, civil disturbance planning and operations. Upon initiation of civil disturbance operations in CONUS, CofSA: directs CGUSCONARC to pre-position and/or move military ground forces to objective areas; alerts the Department of the Air Force to provide needed air transport for the movement(s); tasks other military Services and DOD components for military resources as planned and required; and informs the JCS and unified command commanders of actual or potential loss of military resources.

b. Civil Disturbance operations will be conducted in three phases: Deployment (Phase I), Employment (Phase II), and Redeployment (Phase III).

(1) Phase I - Deployment.

C-2

43

ANNEX C (CONCEPT OF OPERATIONS) TO DEPARTMENT OF THE ARMY CIVIL  
DISTURBANCE PLAN (U)

- (a) The Chief of Staff, US Army, issues a warning order as far in advance as is practicable (appendix 1, this annex). The designated task force commander and appropriate members of his staff normally conduct a reconnaissance of the objective area as soon as possible after being alerted to assess the situation. Resulting recommendations will be made directly to CofSA within two hours of arrival in the objective area. Reconnaissance by task force personnel will be made in civilian clothing using commercial transportation and communications equipment. The state adjutant general will be notified in advance by Chief, National Guard Bureau, of the arrival of the task force commander (appendix 2, this annex) and the foregoing coordinated with the Personal Liaison Officer for the CofSA (PLOCSA) if one is appointed and available (appendix 3, this annex).
- (b) The President issues a proclamation directing that all persons engaged in unlawful obstructions to justice cease and desist, disperse, and retire peaceably (appendix 4, this annex). The President then issues an Executive Order (appendix 5, this annex). Within existing authority, the Secretary of the Army, as DOD Executive Agent, directs civil disturbance operations through CofSA in CONUS and through designated commanders of the unified commands outside of CONUS.
- (c) The CofSA as designated commander of all military ground forces committed, issues a Letter of Instruction (LOI) (appendix 6, this annex) designating the task force commander within CONUS and directs the employment of Federal military resources.
- (d) The Department of the Army transmits to the appropriate state governor and others concerned, messages announcing the calling of Army and designated Air National Guard units and ordering Army Reserve units to active duty (appendix 7 and 8, this annex). The Departments of the Navy and the Air Force will use existing procedures for ordering required Reserve units to active duty.

ANNEX C (CONCEPT OF OPERATIONS) TO DEPARTMENT OF THE ARMY CIVIL  
DISTURBANCE PLAN (U)

44

- (e) The Department of Navy provides required ground forces; makes available airlift resources to the Air Force as requested; mobilizes Reserve units as required; passes operational control of ground forces to CGUSCONARC for movement to and from objective area and operational control to CofSA or the task force commander in the objective area.
  - (f) The Department of the Air Force provides required airlift for air movement of designated forces to objective area(s); provides required ground forces; supports deployed forces by logistic air movements, aerial reconnaissance, and special operations as required; designates specific units of Air National Guard and orders to active duty designated Reserve units as required.
  - (g) CGUSCONARC: Nominates units to comprise task forces required by CofSA; insures readiness of Army forces for movement; plans for and submits airlift and/or surface transportation requirements to DCDPO for designated ground forces; on order, deploys forces to the objective area(s) and on order passes operational control of military ground forces to the CofSA or the task force commander in the objective area.
  - (h) CGUSASTRATCOM: Designates detachment(s) to support task force commander(s) as required, insures readiness of unit for movement, passes operational control to CGUSCONARC for movement to and from objective area(s) and operational control to CofSA or as he may delegate for operations.
- (2) Phase II - Employment. On order of the CofSA, the task force commander assumes operational control of attached military ground forces in the objective area, executes the task force mission, and recommends the effective times and dates for return of control to civil authorities. Logistic support for all ground forces in objective area(s) in CONUS is provided by CGUSCONARC using available resources of all Services.
- (3) Phase III - Redeployment. Following appropriate consultation with the Executive Agent, the CofSA will announce the time and date of termination of Federal intervention and direct the task force commander to



45

ANNEX C (CONCEPT OF OPERATIONS) TO DEPARTMENT OF THE ARMY CIVIL  
DISTURBANCE PLAN (U)

pass operational control of designated ground forces in CONUS to CGUSCONARC for redeployment to home stations. Upon completion of redeployment, forces will be transferred to Military Departments as directed by the CofSA.

3. (U) COORDINATION WITH STATE AND MUNICIPAL OFFICIALS

CGUSCONARC will insure that planning for civil disturbance operations in the 25 High Priority objective areas will include coordination between the task force headquarters (preferably by the task force commander) and state and municipal officials for the purpose of reviewing, coordinating, improving, and supplementing (when Federal intervention occurs) state and local civil disturbance plans. Efforts will be made to establish working relationships and arrangements as deemed suitable for the area in anticipation of Federal intervention. Potential problem areas which cannot be resolved at task force level will be submitted for resolution at the appropriate echelon. The senior civilian representative, DOJ representative, PLOCSA, and DALT will normally assist the task force commander in maintaining harmonious and effective working relationships during the Employment Phase.

4. (U) SPECIAL INSTRUCTIONS

Special instructions are issued to commanders to assist them in civil disturbance operations as considered appropriate (appendix 9, this annex).

5. (U) AREAS OUTSIDE OF CONUS

Civil disturbance operations conducted outside of the CONUS will generally follow procedures stated in this plan as appropriate to the area of operations.

- Appendixes:
- 1 - Warning Order
  - 2 - Notification of Civil Disturbance Task Force Commander's Reconnaissance
  - 3 - Personal Liaison Officer, Chief of Staff, US Army
  - 4 - Presidential Proclamation
  - 5 - Executive Order
  - 6 - Letter of Instruction
  - 7 - Calling Army and Air National Guard Units
  - 8 - DA Message Mobilizing Reserve Units
  - 9 - Special Instructions

CONFIDENTIAL

CONFIDENTIAL

~~CONFIDENTIAL~~ UNCLASSIFIED

RESERVED FOR COMMUNICATION CENTER

<b>JOINT MESSAGEFORM</b>				APPENDIX 1 (WARNING ORDER) TO ANNEX C (CONCEPT OF OPERATIONS) TO DEPARTMENT OF THE ARMY CIVIL DISTURBANCE PLAN (U)	
SECURITY CLASSIFICATION					
CONFIDENTIAL					
TYPE MSG	BOOK	MULTI	SINGLE		
		M			
PRECEDENCE				DTG	
ACTION IMMEDIATE					
INFO IMMEDIATE					
<p>FROM: DA</p> <p>TO: JCS</p> <p>CNO</p> <p>CMC</p> <p>CSAF</p> <p>CMDT USCG</p> <p>CGUSCONARC</p> <p>CINCSTRIKE</p> <p>CGUSASTRATCOM</p> <p>INFO: CINCPANT</p> <p>CINCPAC</p> <p>CGUSAMC</p> <p>CGARADCOM</p> <p>CGUSASA AHS VA</p> <p>CGUSAONE FT MEADE MD</p> <p>CGUSATHREE FT MCPHERSON GA</p> <p>CGUSAFOUR FT SAM HOUSTON TEX</p> <p>CGUSAFIVE FT SHERIDAN ILL</p> <p>CGUSASIX SFRAN CALIF</p> <p>CGUSAINTC FT HOLABIRD MD</p>					<p>SPECIAL INSTRUCTIONS</p> <p>ZFF-1</p> <p>DISTRIBUTION:</p> <p>ARSTAF</p> <p>USCONARC-LNO</p> <p>USAINTC-LNO</p> <p>ASA-LNO</p>
TYPED NAME AND TITLE		PHONE	SIGNATURE		
DRAFTER			G. R. Mather, Lieutenant General, USA DCDPO		
SECURITY CLASSIFICATION		REGRADING INSTRUCTIONS			
CONFIDENTIAL		GROUP 4			

47

DATE	TIME
MONTH	YEAR
PAGE NO. 1	NO. OF PAGES 2

DD FORM 173 1 NOV 63

C-1-1

~~CONFIDENTIAL~~

UNCLASSIFIED

\* GPO : 1966 O-223-087

<b>ABBREVIATED JOINT MESSAGEFORM and/or CONTINUATION SHEET</b>				SECURITY CLASSIFICATION CONFIDENTIAL	
PRECEDENCE ACTION IMMEDIATE INFO IMMEDIATE		RELEASED BY	DRAFTED BY	PHONE	
<p>                     INFO: CGMDW <span style="float: right;">48</span>                      MTMTS WASH DC                      CGXVIII ABN CORPS FT BRAGG NC                      CGIII CORPS FT HOOD TEX                      CG 1ST ARMD DIV FT HOOD TEX                      CG 2D ARMD DIV FT HOOD TEX                      CG 5TH INF DIV (MECH) FT CARSON CO                      CG 82D ABN DIV FT BRAGG NC                      CG 24TH INF DIV FT RILEY KANS                      TCMEASTSEAFRON                      MWESTSEAFRON                 </p> <p>                     CONFIDENTIAL <span style="float: right;">FROM CDPO CDCC</span> </p> <p>                     CMC pass to CGMCDEC, QUANTICO, VA, CGFMFLANT , CGFMFPAC, CG 2D MAR DIV                      CAMP LEJEUNE, NC, CG 5TH MAR DIV CAMP PENDLETON, CA, CNO pass to                      CINCPACFLT and CINCLANTFLT                 </p> <p>                     Subject: Warning Order (GARDEN PLOT)                 </p> <p>                     1. (C) Civil disturbances continue in <u>city(s)</u>, <u>state(s)</u>.                      Local and state law enforcement agencies have been unable to suppress                      the violence and to restore law and order. Prepare to deploy <u>TF</u>  <u>HQ(s), size force(s), STRATCOM Det(s)</u>.                 </p> <p>                     2. (U) Further instructions will be issued as soon as possible.                 </p> <p>                     Group 4                 </p>					
CONTROL NO.	TOR/TOD	PAGE NO. 2	NO. OF PAGES 2	MESSAGE IDENTIFICATION	INITIALS
REGRADING INSTRUCTIONS GROUP 4				SECURITY CLASSIFICATION CONFIDENTIAL	

~~FOR OFFICIAL USE ONLY~~  
RESERVED FOR COMMUNICATION CENTER

<b>JOINT MESSAGEFORM</b>			
SECURITY CLASSIFICATION			
TYPE MSG	BOOK	MULTI	SINGLE
		M	
PRECEDENCE			
ACTION IMMEDIATE			
INFO IMMEDIATE			
			DTG
<p><b>FROM:</b> CNGB, DEPTS OF ARMY AND AF WASH DC</p> <p><b>TO:</b> TAG STATE OF _____</p> <p><b>INFO:</b> JCS</p> <p>CINCSTRIKE</p> <p>CGUSCONARC</p> <p>CGUSA _____</p> <p>CGUSASA AHS VA</p> <p>CGUSAINTC FT HOLABIRD MD</p> <p>_____ TF COMD</p> <p>CGUSASTRATCOM</p> <p>CONFIDENTIAL <span style="float: right;">From Chief, NGB</span></p> <p>Subj: Notification of Task Force Commander's Reconnaissance (GARDEN PLOT)</p> <p>1. ( ) In the event that it becomes necessary for the governor to request Federal troops to cope with civil disturbances in the State of _____, the Federal forces will be commanded by _____ (Task Force Commander).</p> <p>2. ( ) In order to accomplish requisite planning and submit appropriate recommendations, _____, together with selected members of his staff has been authorized to visit your headquarters</p>			<p>SPECIAL INSTRUCTIONS</p> <p>ZFF-1 DISTRIBUTION: ARSTAF USCONARC-LNO USAINTC-LNO USofA</p>
		DATE	TIME
		MONTH	YEAR
		PAGE NO.	NO. OF PAGES
		1	2
D R A F T E R	TYPED NAME AND TITLE	PHONE	SIGNATURE
	DRAFTER		TYPED (or stamped) NAME AND TITLE
		Chief, National Guard Bureau	
SECURITY CLASSIFICATION		REGRADING INSTRUCTIONS	

49

FOR OFFICIAL USE ONLY

ABBREVIATED JOINT MESSAGEFORM and/or CONTINUATION SHEET				SECURITY CLASSIFICATION				
PRECEDENCE		RELEASED BY		DRAFTED BY		PHONE		
ACTION IMMEDIATE								
INFO IMMEDIATE								
<p>by the CofSA. His visit is for coordination and planning as a precautionary measure in anticipation of the possible commitment of the Federal troops and should not be interpreted as Federal intervention. Any assistance you may furnish him will be greatly appreciated.</p> <p>(This message will be classified CONFIDENTIAL with appropriate regrading instructions when completed.)</p>								
CONTROL NO.		TOR/TOD		PAGE NO.	NO. OF PAGES	MESSAGE IDENTIFICATION		INITIALS
				2	2			
REGRADING INSTRUCTIONS					SECURITY CLASSIFICATION			

50

DD FORM 173-1

C-2-2

REPL

FOR OFFICIAL USE ONLY

WILL BE USED.

51

APPENDIX 3 (PERSONAL LIAISON OFFICER, CHIEF OF STAFF, US ARMY)  
TO ANNEX C (CONCEPT OF OPERATIONS) TO DEPARTMENT OF THE ARMY  
CIVIL DISTURBANCE PLAN (U)

1. GENERAL

a. The Chief of Staff, United States Army, as the commander of all Federal military ground forces committed to civil disturbance operations in CONUS, issues a Letter of Instruction (LOI) to the task force commander designating him the commander of all assigned and attached Federal military ground forces in the objective area.

b. The CofSA normally designates an officer of Major General rank as his personal liaison officer (PLOCSA) to the task force commander. A Department of the Army Liaison Team (DALT) consisting of a representative from DCDPO, ODCSPER, ODCSLOG, OACSI, OCINFO, OACSC-E, OTJAG, and OTPMG, accompanies and assists the PLOCSA. A PLOCSA and DALT are normally provided each task force commander except for the Washington, DC, objective area and will be dispatched on order of the CofSA.

2. PURPOSE

a. The PLOCSA provides the task force commander with specific guidance from the CofSA, and performs other functions as designated by the CofSA.

b. The DALT serve as the staff of the PLOCSA and are responsive to his direction. In addition, they will assist, as required and authorized, members of the task force commander's staff by providing guidance pertaining to DA policy in their particular fields of staff expertise.

3. ADMINISTRATION

a. The Secretary of the General Staff provides the Directorate for Civil Disturbance Planning and Operations a list of designated general officers approved by the CofSA to perform the duties of the PLOCSA.

b. The designated staff agencies provide a roster of personnel that are designated to serve as members of the DALT.

c. The Directorate for Civil Disturbance Planning and Operations (DCDPO) maintains the current roster of designated PLOCSA and members of the DALT.

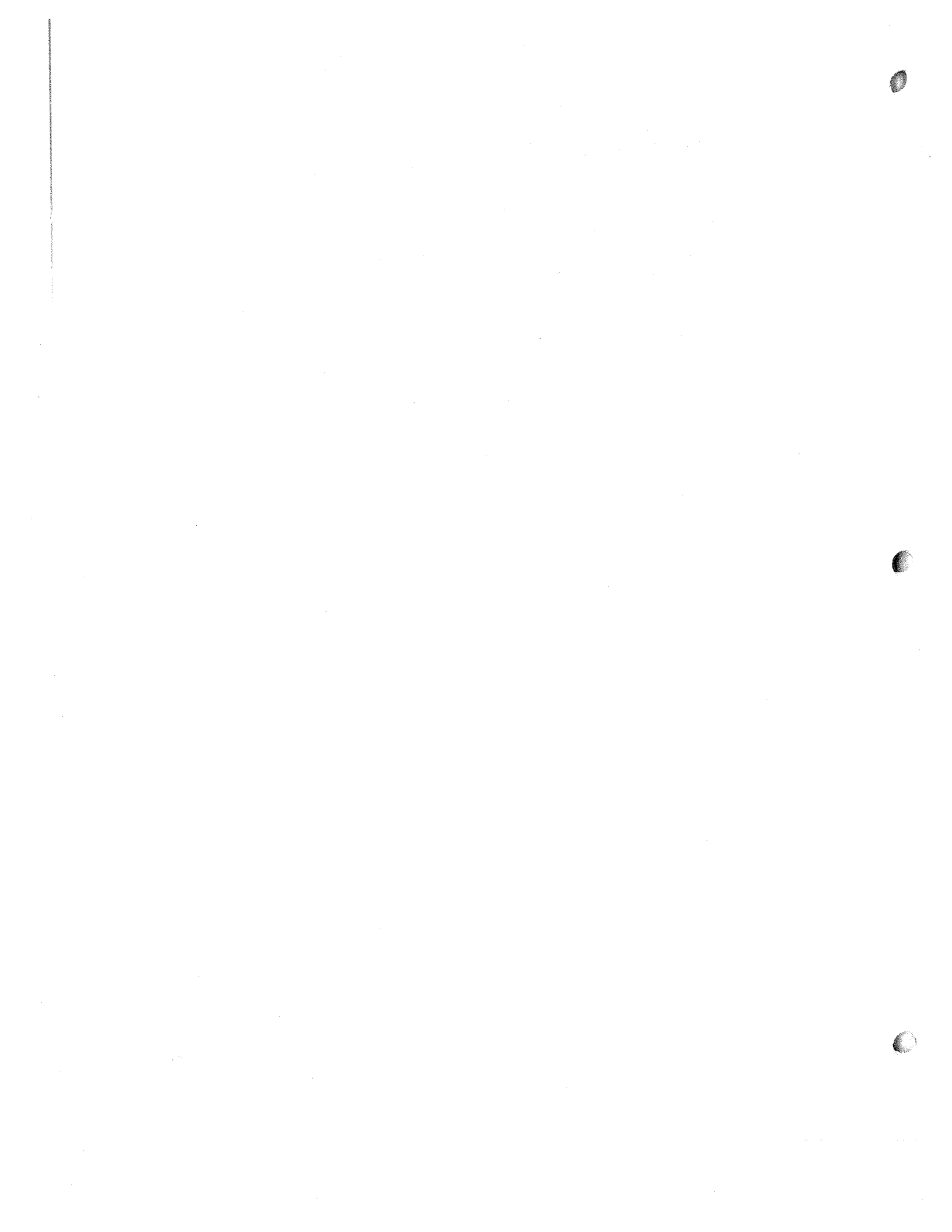



53

APPENDIX 4 (PRESIDENTIAL PROCLAMATION) TO ANNEX C (CONCEPT OF OPERATIONS) TO DEPARTMENT OF THE ARMY CIVIL DISTURBANCE PLAN (U)

THE WHITE HOUSE

LAW AND ORDER IN THE STATE OF \_\_\_\_\_

-----

BY THE PRESIDENT OF THE UNITED STATES OF AMERICA

A PROCLAMATION

WHEREAS the Governor of the State of \_\_\_\_\_ has informed me that conditions of domestic violence and disorder exist in \_\_\_\_\_ in that State, obstructing the execution and enforcement of the laws, and that the law enforcement resources available to the City and State, including the National Guard, have been unable to suppress such acts of violence and to restore law and order; and

WHEREAS the Governor has requested me to use such of the Armed Forces of the United States as may be necessary for those purposes; and

WHEREAS such domestic violence and disorder are also obstructing the execution of the laws of the United States, including the protection of Federal property in \_\_\_\_\_:

NOW, THEREFORE, I, \_\_\_\_\_, President of the United States of America, by virtue of the authority vested in me by the Constitution and laws of the United States, including Chapter 15 of Title 10 of the United States Code, do command all persons engaged in such acts of violence to cease and desist therefrom and to disperse and retire peaceably forthwith.

IN WITNESS WHEREOF, I have hereunto set my hand this \_\_\_\_\_ day of \_\_\_\_\_ in the year of our Lord nineteen hundred and \_\_\_\_\_, and the Independence of the United States of America the one hundred and \_\_\_\_\_.

(Signature of the President)

THE WHITE HOUSE



55

APPENDIX 5 (EXECUTIVE ORDER) TO ANNEX C (CONCEPT OF OPERATIONS)  
TO DEPARTMENT OF THE ARMY CIVIL DISTURBANCE PLAN (U)

THE WHITE HOUSE

EXECUTIVE ORDER

-----

PROVIDING FOR THE RESTORATION OF LAW AND ORDER

IN THE STATE OF \_\_\_\_\_

WHEREAS I have today issued Proclamation No. \_\_\_\_\_, pursuant in part to the provisions of Chapter 15 of Title 10 of the United States Code, and

WHEREAS the conditions of domestic violence and disorder described therein continue, and the persons engaging in such acts of violence have not dispersed,

NOW, THEREFORE, by virtue of the authority vested in me as President of the United States and Commander in Chief of the Armed Forces by the Constitution and Laws of the United States, including Chapter 15 of Title 10 of the United States Code, Section 301 of Title 3 of the United States Code, and Public Law 90-\*, it is hereby ordered as follows:

SECTION 1. The Secretary of Defense is authorized and directed to take all appropriate steps to disperse all persons engaged in the acts of violence described in the proclamation and to restore law and order.

SECTION 2. In carrying out the provisions of Section 1, the Secretary of Defense is authorized to use such of the Armed Forces of the United States as he may deem necessary.

SECTION 3. The Secretary of Defense is hereby authorized and directed to call into the active military service of the United States, as he may deem appropriate to carry out the purposes of this order, units or members of the Army National Guard and of the Air National Guard to serve in the active military service of the

\*At this date, it is anticipated that the 90th Congress will enact a law to provide for the employment of Reserve forces in civil disturbance operations.

C-5-1

APPENDIX 5 (EXECUTIVE ORDER) TO ANNEX C (CONCEPT OF OPERATIONS)  
TO DEPARTMENT OF THE ARMY CIVIL DISTURBANCE PLAN (U)

56

United States for an indefinite period and until relieved by appropriate orders. Units or members may be relieved subject to recall at the discretion of the Secretary of Defense. In carrying out the provisions of Section 1, the Secretary of Defense is authorized to use units and members called or recalled into the active military service of the United States pursuant to this section.

SECTION 4. The Secretary of Defense is hereby authorized and directed to order to active military duty, as he may deem appropriate to carry out the purposes of this order, units of the Reserve Components of the Armed Forces to serve in the active military service of the United States for an indefinite period and until relieved by appropriate orders. Units may be relieved subject to reorder at the discretion of the Secretary of Defense. In carrying out the provisions of Section 1, the Secretary of Defense is authorized to use units ordered or reordered to active military duty pursuant to this section.

SECTION 5. The Secretary of Defense is authorized to delegate to one or more of the Secretaries of the Military Departments any of the authority conferred upon him by this order.

(Signature of the President)

THE WHITE HOUSE

C-5-2

UNCLASSIFIED

~~CONFIDENTIAL~~

RESERVED FOR COMMUNICATION CENTER

<b>JOINT MESSAGEFORM</b>				APPENDIX 6 (COFSA LETTER OF INSTRUCTION) TO ANNEX C (CONCEPT OF OPERATIONS) TO DEPARTMENT OF THE ARMY CIVIL DISTURBANCE PLAN (U)	
SECURITY CLASSIFICATION CONFIDENTIAL					
57	TYPE MSG	BOOK	MULTI M	SINGLE	
	PRECEDENCE				
ACTION IMMEDIATE					
INFO IMMEDIATE				DTG	
FROM: DA				SPECIAL INSTRUCTIONS	
TO: (TASK FORCE COMMANDER)				DISTRIBUTION:	
INFO: JCS				ARSTAF	
DEPT OF JUSTICE				PLUS:	
CNO - COURIER				SECDEF	
CMC - COURIER				OSA	
CSAF - COURIER				OUSA	
COMDT USCG - COURIER				CLL	
CGUSCONARC				TIG	
CINCARSTRIKE				OCINFO	
CGUSAONE FT MEADE MD				USCONARC-LNO	
CGUSATHREE FT MCPHERSON GA				USAINTC-LNO	
CGUSAFOUR FT SAM HOUSTON TEX				NMCC	
CGUAFIVE FT SHERIDAN ILL					
CGUSASIX SFRAN CALIF					
CGXVIII ABN CORPS FT BRAGG NC					
CG III CORPS FT HOOD TEX					
CGMDW WASH DC - COURIER				DATE	
CINCSTRIKE				TIME	
CGUSAMC				MONTH	
				YEAR	
				PAGE NO. 1	
				NO. OF PAGES 11	
D R A F T E R	TYPED NAME AND TITLE		PHONE	SIGNATURE	
	DRAFTER			TYPED (or stamped) NAME AND TITLE W. C. WESTMORELAND, General, USA Chief of Staff, US Army	
SECURITY CLASSIFICATION CONFIDENTIAL				REGRADING INSTRUCTIONS	

DD FORM 173 1 NOV 63 C-6-1

~~CONFIDENTIAL~~

WHICH WILL BE USED.

UNCLASSIFIED

UNCLASSIFIED

~~CONFIDENTIAL~~

<b>ABBREVIATED JOINT MESSAGEFORM</b> and/or CONTINUATION SHEET				SECURITY CLASSIFICATION CONFIDENTIAL				
PRECEDENCE		RELEASED BY		DRAFTED BY		PHONE		
ACTION IMMEDIATE								
INFO IMMEDIATE								
<p style="text-align: right;">7</p> <p>CGUSACDC</p> <p>CGUSARADCOM</p> <p>CGUSASA</p> <p>CGUSAINTC FT HOLABIRD MD</p> <p>CGUSASTRATCOM FT HUACHUCA ARIZ</p> <p>CG DC NG DC ARMORY WASH DC - COURIER</p> <p>(DELETE WHEN DC IS NOT INVOLVED IN CIVIL DISTURBANCE)</p> <p>PERSONAL LIAISON OFFICER, CHIEF OF STAFF, USA</p> <p>C O N F I D E N T I A L</p> <p>From: GEN W. C. Westmoreland</p> <p>DOJ for the Attorney General</p> <p>Chief of Staff, United States Army</p> <p>Subj: Letter of Instruction GARDEN PLOT</p> <p>1. (C) For immediate action by _____, Task Force Commander.</p> <p>2. (C) This letter of instruction is effective on receipt for planning and preparatory action. It is effective for execution on order of the Chief of Staff, US Army.</p> <p>3. (C) Command and control.</p> <p>a. _____, you are designated commander of Task Force ____.</p> <p>Your mission is to restore and maintain law and order in _____.</p> <p>Units for Task Force _____ will be designated. Be prepared to</p>								
CONTROL NO.		TOR/TOD		PAGE NO.	NO. OF PAGES	MESSAGE IDENTIFICATION		INITIALS
				2	11			
REGRADE INSTRUCTIONS						SECURITY CLASSIFICATION		
						CONFIDENTIAL		

58

DD FORM 173-1

1 NOV 63

C-6-2

~~CONFIDENTIAL~~

WILL BE USED.

UNCLASSIFIED

ABBREVIATED JOINT MESSAGEFORM and/or CONTINUATION SHEET				SECURITY CLASSIFICATION CONFIDENTIAL	
PRECEDENCE	RELEASED BY	DRAFTED BY		PHONE	
ACTION IMMEDIATE					
INFO IMMEDIATE					
<p>59</p> <p>assume operational control of and employ additional Active Army, Navy, Air Force, Marine Corps, Coast Guard, National Guard, and other Reserve component units of all Services called or ordered to active duty under Presidential authority.</p> <p>b. In carrying out your duties, you will be directly responsible to the Chief of Staff, US Army. You will establish your command post at _____ and report subsequent locations. You are authorized direct communications with Army, Navy, Air Force, and Marine Corps and Coast Guard installation commanders in the vicinity of your operation.</p> <p>c. The Attorney General will appoint a Senior Civilian Representative with appropriate support for the objective city. You will consult with the Senior Civilian Representative regarding military operations and decisions when feasible. The Senior Civilian Representative, in consultation with you, will establish and maintain liaison with the mayor, governor, and other civil authorities of Federal, state and local governments in the objective area. He will coordinate the Federal civilian efforts to assist in the administration of justice, in the detention of prisoners, in arranging for emergency relief measures, and in other civil matters. You will promptly advise the Chief of Staff, US Army, of instructions received from the Senior</p>					
CONTROL NO.	TOR/TOD	PAGE NO.	NO. OF PAGES	MESSAGE IDENTIFICATION	INITIALS
		3	11		
REGRADING INSTRUCTIONS				SECURITY CLASSIFICATION CONFIDENTIAL	

UNCLASSIFIED

~~CONFIDENTIAL~~

ABBREVIATED JOINT MESSAGEFORM and/or CONTINUATION SHEET				SECURITY CLASSIFICATION CONFIDENTIAL		
PRECEDENCE		RELEASED BY		DRAFTED BY		PHONE
ACTION IMMEDIATE						
INFO IMMEDIATE						
<p>Civilian Representative and action taken in accordance therewith. The Senior Civilian Representative will be located at your command post.</p> <p>d. You will cooperate with and assist municipal law enforcement officers to assume their normal roles. In this regard, you will not take orders from civilian authorities, except as discussed in 3c above.</p> <p>e. An on-site DOD Public Affairs Chief will be designated by the ASD (PA) to furnish public affairs advice and guidance to you. In the event of a disagreement between you and the ASD (PA) representative concerning the public release of information, you will report the fact to the Chief of Staff, US Army; however, the issue will be resolved by the ASD (PA) in coordination, where possible, with the DOD Executive Agent (the Secretary of the Army).</p> <p>f. _____ is designated as the Personal Liaison Officer, Chief of Staff, US Army, for this operation and is available for such assistance and advice as you desire. Also, the following DA representatives have been provided to _____ as his liaison team:</p> <p>(1) _____, a representative of the Office of the Chief of Information to assist in public and command information matters.</p> <p>(2) _____, a representative of the Office of the Assistant Chief of Staff for Communications-Electronics, to assist in _____</p>						
CONTROL NO.	TOR/TOD	PAGE NO.	NO. OF PAGES	MESSAGE IDENTIFICATION		INITIALS
		4	11			
REGRADE INSTRUCTIONS				SECURITY CLASSIFICATION CONFIDENTIAL		

60

DD FORM 173-1  
NOV 63

C-6-4

REPL

~~CONFIDENTIAL~~

LL BE USED.

UNCLASSIFIED



ABBREVIATED JOINT MESSAGEFORM and/or CONTINUATION SHEET				SECURITY CLASSIFICATION CONFIDENTIAL	
PRECEDENCE	RELEASED BY	DRAFTED BY	PHONE		
ACTION	IMMEDIATE				
INFO	IMMEDIATE				
<p>Communications-Electronics matters. <span style="float: right;">7</span></p> <p>61 (3) _____, a representative of the Office of The Provost Marshal General, to assist in the coordination with local law enforcement agencies.</p> <p>(4) _____, a Judge Advocate General representative to provide legal advice.</p> <p>(5) _____, a representative of the Assistant Chief of Staff for Intelligence, to assist in intelligence matters.</p> <p>(6) _____, a representative of the Deputy Chief of Staff for Logistics to assist in logistical matters.</p> <p>(7) _____, a representative of the Directorate for Civil Disturbance Planning and Operations to assist in operational matters.</p> <p>(8) _____, a representative of the Deputy Chief of Staff for Personnel to assist in personnel matters.</p> <p>g. The Directorate for Civil Disturbance Planning and Operations is responsible for establishing and maintaining communications between your command post location and the DA Civil Disturbance Command Center, Washington, DC. Direct communication with DA is authorized and directed. You will insure that continuous contact is maintained with DA/CDCC from time of arrival in _____.</p> <p style="text-align: right;">└</p>					
CONTROL NO.	TOR/TOD	PAGE NO.	NO. OF PAGES	MESSAGE IDENTIFICATION	INITIALS
		5	11		
REGRADING INSTRUCTIONS				SECURITY CLASSIFICATION CONFIDENTIAL	

UNCLASSIFIED

~~CONFIDENTIAL~~

ABBREVIATED JOINT MESSAGEFORM and/or CONTINUATION SHEET				SECURITY CLASSIFICATION CONFIDENTIAL				
PRECEDENCE		RELEASED BY		DRAFTED BY		PHONE		
ACTION IMMEDIATE								
INFO IMMEDIATE								
<p>h. You will be met on arrival in _____ by _____ the senior representative of the USAINTC in the area. He will brief you on the current situation and assist in other ways on request.</p> <p>4. (C) Application of Force.</p> <p>a. Minimum force, consistent with mission accomplishment, will be used by both military and civilian personnel. Moreover, commanders and their personnel should do whatever is possible to appear as a force whose purpose is to restore order with a minimum loss of life and property rather than an irruptive, hostile force. Further, due respect will be shown for the great number of citizens whose involvement is purely accidental. For example, while riot control personnel should be visible, force concentrations which might tend more to excite than to calm should be avoided where possible. Your force options for determining how your troops may be armed to accomplish your mission are enumerated in appendix 9 to annex C of Department of the Army Civil Disturbance Plan.</p> <p>b. You are authorized to use riot control agents, and to delegate this authority to commissioned officers at your discretion. Furthermore, riot control agents should be used to accomplish your mission prior to the use of live ammunition.</p>								
CONTROL NO.		TOR/TOD		PAGE NO.	NO. OF PAGES	MESSAGE IDENTIFICATION		INITIALS
				6	11			
REGRAIDING INSTRUCTIONS				SECURITY CLASSIFICATION CONFIDENTIAL				

62

DD FORM 173-1  
1 NOV 63

C-6-6

REPL

~~CONFIDENTIAL~~

-L BE USED.

UNCLASSIFIED

ABBREVIATED JOINT MESSAGEFORM and/or CONTINUATION SHEET				SECURITY CLASSIFICATION CONFIDENTIAL	
PRECEDENCE	RELEASED BY	DRAFTED BY	PHONE		
ACTION	IMMEDIATE				
INFO	IMMEDIATE				
<p>63</p> <p>c. Authority to issue live ammunition to personnel under your command is authorized. They are not to load or fire their weapons except when authorized by an officer in person; when authorized in advance by an officer under certain specific conditions; or when required to save their lives. Warning shots will not be fired; however, when shooting is necessary, shots will be aimed to wound rather than to kill.</p> <p>d. You are authorized to use force to prevent sniping, arson, looting, or other serious crimes against public order, and to detain persons caught in these acts. The amount of force which may be used is that which is reasonably necessary under the circumstances. Deadly force will not be used in connection with minor offenses such as curfew violations. The use of deadly force is authorized only when other methods will not suffice to prevent a serious crime or to apprehend the offender. Use of a deadly force is not acceptable when less dangerous means will accomplish the objective; it will be used only as a last resort. You will insure positive control over use of weapons.</p> <p>(1) Officers may authorize personnel to fire their weapons when necessary to subdue snipers after other means to overcome such persons have not been successful. Well-aimed fire by expert marksmen should be used whenever possible.</p>					
CONTROL NO.	TOR/TOD	PAGE NO. 7	NO. OF PAGES 11	MESSAGE IDENTIFICATION	INITIALS
REGRADING INSTRUCTIONS				SECURITY CLASSIFICATION CONFIDENTIAL	

DD FORM 173-1  
1 NOV 63

C-6-7

REPI

~~CONFIDENTIAL~~

WILL BE USED.

UNCLASSIFIED

UNCLASSIFIED

~~CONFIDENTIAL~~

ABBREVIATED JOINT MESSAGEFORM and/or CONTINUATION SHEET				SECURITY CLASSIFICATION CONFIDENTIAL	
PRECEDENCE		RELEASED BY		DRAFTED BY	
ACTION IMMEDIATE					
INFO IMMEDIATE					
<p>(2) The prevention of arson requires immediate and decisive action. The firing of weapons may be required and is authorized to prevent acts of arson, which would cause loss of human life or destruction of facilities vital to public safety and the conduct of the government.</p> <p>(3) There is no satisfactory predetermination as to when shooting should be employed to stop looting. Shooting should not normally be used to prevent looting, or to prevent the escape of persons suspected of this act. However, every effort will be made to take these people into custody in order to prevent its spreading to those who would not normally loot except when caught up in the contagion of other acts of disorder.</p> <p>e. Whenever possible, civilian police authorities should take civilian personnel into custody; however, when assistance is necessary or in the absence of the civilian police, Federal military forces have the responsibility to detain or take into custody rioters, looters, or others committing offenses. In any case, military personnel will furnish any information required by civilian police to execute an arrest form. A copy of any detention form that is executed will be furnished to the civilian police. Should a situation arise necessitating the detention of civilian personnel, civil police, possibly in collaboration with local Department of Justice personnel, will operate and</p>					
CONTROL NO.	TOR/TOD	PAGE NO. 8	NO. OF PAGES 11	MESSAGE IDENTIFICATION	INITIALS
REGRAIDING INSTRUCTIONS				SECURITY CLASSIFICATION CONFIDENTIAL	

64

DD FORM 173-1

C-6-8

REP ~~CONFIDENTIAL~~

WILL BE USED.

UNCLASSIFIED

~~CONFIDENTIAL~~

UNCLASSIFIED

PRECEDENCE		RELEASED BY		DRAFTED BY		PHONE	
ACTION IMMEDIATE							
INFO IMMEDIATE							

65

ABBREVIATED JOINT MESSAGEFORM  
and/or CONTINUATION SHEET

SECURITY CLASSIFICATION  
CONFIDENTIAL

f. In carrying out your mission to restore and maintain law and order, task force personnel may conduct searches of individuals and private property (including automobiles) in the following situations:

(1) If they have reason to believe that an individual is armed or is carrying instruments of violence, they may search the individual for such weapons.

(2) If they have reason to believe that an individual who has committed, who is about to commit, or who is committing a crime of violence is hidden in a building or automobile, they may search the building or automobile for the individual and his weapons.

(3) If they have stopped an automobile and there is reason to believe that the vehicle contains weapons or instruments of violence, they may search the vehicle for these weapons or instruments of violence.

In addition, in carrying out your mission to restore and maintain law and order, it may be necessary to conduct searches of individuals or private property (including automobiles) in other situations. You must review the evidence forming the basis of a request for task personnel to conduct such searches. As a general rule, such searches should be carried out by local and state civil law enforcement personnel because of their greater familiarity with standards

CONTROL NO.	TOR/TOD	PAGE NO.	NO. OF PAGES	MESSAGE IDENTIFICATION	INITIALS
		9	11		
REGRADING INSTRUCTIONS				SECURITY CLASSIFICATION CONFIDENTIAL	

DD FORM 173-1 C-6-9  
1 NOV 63

REF ~~CONFIDENTIAL~~ WILL BE USED.

UNCLASSIFIED

UNCLASSIFIED

~~CONFIDENTIAL~~

ABBREVIATED JOINT MESSAGEFORM and/or CONTINUATION SHEET				SECURITY CLASSIFICATION CONFIDENTIAL	
PRECEDENCE	RELEASED BY	DRAFTED BY	PHONE		
ACTION				IMMEDIATE	
INFO				IMMEDIATE	
<p>for searches, including the use of judicial warrants. However, you <input type="checkbox"/> may authorize task force personnel to conduct such searches if you determine that it is reasonably necessary to the accomplishment of your mission and that there is an immediate danger of violence unless the search is begun without delay. In all other such cases responsibility for the search should be turned over to civil law enforcement personnel to be conducted according to local procedures. You may delegate this authority to subordinate military commanders no lower than the grade of lieutenant colonel. The commander authorizing such search will fully document the reasons for the search, including the events indicating that the search is necessary, the identity of those things sought, and the source and content of the information leading to the conclusion that the items sought will probably be found in the place searched.</p> <p>5. (U) Reports. You will insure that DA is fully informed on operations through the submission of:</p> <p>a. Interim telephonic reports on major changes or significant events which warrant the immediate attention of Headquarters, DA.</p> <p>b. Situation reports will be submitted to DA/CDCC daily as of 1000Z and 2000Z not later than 1200Z and 2200Z respectively for the "as of date." Reports may be by telephone or message. Telephonic <input type="checkbox"/></p>					
CONTROL NO.	TOR/TOD	PAGE NO. 10	NO. OF PAGES 11	MESSAGE IDENTIFICATION	INITIALS
REGRADING INSTRUCTIONS				SECURITY CLASSIFICATION CONFIDENTIAL	

66

DD FORM 173-1 C-6-10

REF ~~CONFIDENTIAL~~

LL BE USED.

UNCLASSIFIED

UNCLASSIFIED

~~CONFIDENTIAL~~

ABBREVIATED JOINT MESSAGEFORM and/or CONTINUATION SHEET				SECURITY CLASSIFICATION CONFIDENTIAL	
PRECEDENCE	RELEASED BY	DRAFTED BY		PHONE	
ACTION IMMEDIATE					
INFO IMMEDIATE					
<p>67 reports will be confirmed by message. Initial report as of ____.</p> <p>6. (C) Future teletype correspondence on this operation will be prefaced by the words "Task Force ____."</p> <p>7. (C) Upon execution, this letter is regraded UNCLASSIFIED.</p> <p>8. (U) Acknowledge receipt of this letter to Team Chief, Civil Disturbance Command Center, Pentagon, Washington, D. C. (OX 5-0441 x251).</p>					
CONTROL NO.	TOR/TOD	PAGE NO.	NO. OF PAGES	MESSAGE IDENTIFICATION	INITIALS
		11	11		
REGRADING INSTRUCTIONS				SECURITY CLASSIFICATION CONFIDENTIAL	

DD FORM 173-1 C-6-11

REF ~~CONFIDENTIAL~~

LL BE USED.

UNCLASSIFIED

CONFIDENTIAL

7



<b>JOINT MESSAGEFORM</b>				<u>APPENDIX 7 (CALLING ARMY AND AIR NG UNITS) TO ANNEX C (CONCEPT OF OPERATIONS) TO DEPARTMENT OF THE ARMY CIVIL DISTURBANCE PLAN (U)</u>			
SECURITY CLASSIFICATION UNCLAS E F T O FOUO							
TYPE MSG	BOOK	MULTI	SINGLE				
		M					
PRECEDENCE							
ACTION	IMMEDIATE						
INFO	IMMEDIATE			DTG			
<p>69 FROM: DA</p> <p>TO: TAG STATE OF _____</p> <p>CGUSCONARC</p> <p>CSAF</p> <p>INFO: JCS</p> <p>CINCSTRIKE</p> <p>CGUSASA AHS VA</p> <p>CGUSAINTC FT HOLABIRD MD</p> <p>UNCLAS E F T O FOUO From Secretary of the Army</p> <p>State AG of _____ pass to the Governor of _____</p> <p>Subject: Calling of Army and Air NG Units (GARDEN PLOT)</p> <p>In order to enforce the laws of _____ and of the United States in _____, the President has exercised the authority vested in him by the Constitution and laws of the United States to authorize the Secretary of Defense by Executive Order ____, providing for the restoration of law and order in _____, dated _____, to call units and members of the Army National Guard and the Air National Guard of the State of _____</p>							<p>SPECIAL INSTRUCTIONS</p> <p>ZFF-1</p> <p>DISTRIBUTION:</p> <p>ARDIST plus</p> <p>DOD</p> <p>USCONARC-LNO</p>
				DATE	TIME		
				MONTH	YEAR		
				PAGE NO.	NO. OF PAGES		
				1	3		
D R A F T E R	TYPED NAME AND TITLE		PHONE	SIGNATURE			
	DRAFTER						
				TYPED (or stamped) NAME AND TITLE			
				Honorable _____			
				Secretary of the Army			
SECURITY CLASSIFICATION UNCLAS E F T O FOUO				REGRADING INSTRUCTIONS			

ABBREVIATED JOINT MESSAGEFORM and/or CONTINUATION SHEET				SECURITY CLASSIFICATION UNCLAS E F T O FOUO					
PRECEDENCE	RELEASED BY	DRAFTED BY	PHONE						
ACTION IMMEDIATE									
INFO IMMEDIATE									
<p>into active Federal service as necessary for the purpose and by virtue of the authority conferred upon me under the provisions of DOD Directive 3025.12 I hereby call into active Federal service for an indefinite period and until relieved by appropriate orders as of and from _____ hours, ZULU, ____, 19__, all of the units and members of the Army National Guard of the State of _____, except _____; _____ which shall be assembled as directed by _____, US Army, in the State of _____ and placed under his command.</p> <p>I further call into active military service of the United States for an indefinite period and until relieved by appropriate orders as of and from _____ hours, ZULU, ____, 19__, the following units and members of the Air National Guard of the State of _____.</p> <table border="0"> <tr> <td style="text-align: center;"><u>Unit</u></td> <td style="text-align: center;"><u>Gaining Command</u></td> </tr> <tr> <td style="text-align: center;">* * * * *</td> <td style="text-align: center;">* * * * *</td> </tr> </table> <p>These Air National Guard units will be placed under the command of the designated gaining commands.</p> <p>The Adjutant General of _____ will furnish copies of the above orders to the commanding officers of the Army National Guard of the State of _____.</p>						<u>Unit</u>	<u>Gaining Command</u>	* * * * *	* * * * *
<u>Unit</u>	<u>Gaining Command</u>								
* * * * *	* * * * *								
CONTROL NO.	TOR/TOD	PAGE NO. 2	NO. OF PAGES 3	MESSAGE IDENTIFICATION	INITIALS				
REGRADE INSTRUCTIONS				SECURITY CLASSIFICATION UNCLAS E F T O FOUO					

70

~~FOR OFFICIAL USE ONLY~~

<b>ABBREVIATED JOINT MESSAGEFORM and/or CONTINUATION SHEET</b>				SECURITY CLASSIFICATION UNCLAS E F T O FOUO				
PRECEDENCE		RELEASED BY		DRAFTED BY		PHONE		
ACTION IMMEDIATE								
INFO IMMEDIATE								
<p>71            Those provisions of mobilization regulations changing established National Guard administrative, property, and supply procedures when entering active duty are waived except for the provisions governing the preparation and distribution of morning reports, the subsistence of troops, and the preparation of DD Form 220. Standard Form 88 will be checked to determine date of last physical examination. If physical was not completed within preceding 12 months, Standard Form 88 will be completed within 10 days, or prior to release from active duty period if active duty period is less than 10 days. Cancellation of protective markings cannot be predetermined.</p>								
CONTROL NO.		TOR/TOD		PAGE NO. 3	NO. OF PAGES 3	MESSAGE IDENTIFICATION		INITIALS
REGRADING INSTRUCTIONS					SECURITY CLASSIFICATION UNCLAS E F T O FOUO			

DD FORM 173-1 C-7-3 1 NOV 63

REPLACES E

~~FOR OFFICIAL USE ONLY~~ E USED.



<b>JOINT MESSAGEFORM</b>				<i>RESERVED FOR COMMUNICATION CENTER</i>				
SECURITY CLASSIFICATION UNCLAS E F T O FOUO				APPENDIX 8 (DA MESSAGE MOBILIZING RESERVE UNITS) TO ANNEX C (CONCEPT OF OPERATIONS) TO DEPARTMENT OF THE ARMY CIVIL DISTURBANCE PLAN (U)				
TYPE MSG	BOOK	MULTI M	SINGLE					
PRECEDENCE								
ACTION	IMMEDIATE							
INFO	IMMEDIATE							
				DTG				
<p style="text-align: center;"><b>FROM:</b> DA</p> <p style="text-align: center;"><b>TO:</b> CGUSCONARC</p> <p style="text-align: center;"><b>INFO:</b> JCS</p> <p style="text-align: center;">CINCSTRIKE</p> <p style="text-align: center;">CGUSAMC</p> <p style="text-align: center;">CGARADCOM</p> <p style="text-align: center;">CGUSASTRATCOM</p> <p style="text-align: center;">CGUSASA AHS VA</p> <p style="text-align: center;">CGUSAINTC FT HOLABIRD MD</p> <p style="text-align: center;">MTMTS WASH DC</p> <p>UNCLAS E F T O FOUO <span style="float: right;">FROM Secretary of the Army</span></p> <p>Subject: Mobilization of Reserve Units (GARDEN PLOT)</p> <p>In order to enforce the laws of the United States, the President has exercised the authority vested in him by the Constitution and laws of the United States to authorize the Secretary of Defense to order Reserve Component units of the Army to active duty as necessary for the purpose of restoring law and order in <u>(area where civil disturbance occurs)</u>.</p> <p>By virtue of the authority delegated to me by the Secretary of</p>							<p style="text-align: center;">SPECIAL INSTRUCTIONS</p> <p>ZFF-1 DISTRIBUTION: ARDIST plus DOD USCONARC-LNO</p>	
							DATE	TIME
							MONTH	YEAR
							PAGE NO. 1	NO. OF PAGES 2
D R A F T E R	TYPED NAME AND TITLE  DRAFTER			PHONE	SIGNATURE			
					TYPED (or stamped) NAME AND TITLE Secretary of the Army			
SECURITY CLASSIFICATION UNCLAS E F T O FOUO					REGRADING INSTRUCTIONS			

73

~~FOR OFFICIAL USE ONLY~~

74

<b>ABBREVIATED JOINT MESSAGEFORM and/or CONTINUATION SHEET</b>				SECURITY CLASSIFICATION  UNCLAS E F T O FOUO									
PRECEDENCE		RELEASED BY		DRAFTED BY		PHONE							
ACTION IMMEDIATE													
INFO IMMEDIATE													
<p>Defense, I hereby order to active duty for an indefinite period and until relieved by appropriate orders as of and from _____ hours, ZULU, _____, 19____, the units listed below which shall be assembled as directed by (TF Commander) _____, US Army, and placed under his operational control for employment.</p> <table border="1" style="width: 100%; border-collapse: collapse;"> <thead> <tr> <th style="text-align: left;">DESIGNATION OF UNIT</th> <th style="text-align: left;">STRENGTH</th> <th style="text-align: left;">DUTY STATION</th> </tr> </thead> <tbody> <tr> <td style="text-align: center;">* * * * *</td> <td style="text-align: center;">* * * * *</td> <td style="text-align: center;">* * * * *</td> </tr> </tbody> </table> <p>Those provisions of mobilization regulations changing established USAR administrative, property, and supply procedures when entering active duty are waived except for the provisions governing the preparation and distribution of morning reports, the subsistence of troops and the preparation of DD Form 220. Standard Form 88 will be checked to determine date of last physical examination. If physical was not completed within preceding 12 months, Standard Form 88 will be completed within 10 days, or prior to release from active duty period if active duty period is less than 10 days.</p> <p>Commanding General, US Continental Army Command will furnish necessary administrative and logistical support to USAR units. Operational matters will be directed by Chief of Staff, US Army. Cancellation of protective markings cannot be predetermined.</p>								DESIGNATION OF UNIT	STRENGTH	DUTY STATION	* * * * *	* * * * *	* * * * *
DESIGNATION OF UNIT	STRENGTH	DUTY STATION											
* * * * *	* * * * *	* * * * *											
CONTROL NO.		TOR/TOD		PAGE NO.	NO. OF PAGES	MESSAGE IDENTIFICATION		INITIALS					
				2	2								
REGRAIDING INSTRUCTIONS					SECURITY CLASSIFICATION UNCLAS E F T O FOUO								

DD FORM 173-1

NOV 83

C-8-2

REPLACES E

~~FOR OFFICIAL USE ONLY~~ E USED.

75

APPENDIX 9 (SPECIAL INSTRUCTIONS) TO ANNEX C (CONCEPT OF OPERATIONS)  
TO DEPARTMENT OF THE ARMY CIVIL DISTURBANCE PLAN (U)

1. (C) APPLICATION OF FORCE

a. Minimum force, consistent with mission accomplishment, will be used by military personnel. Commanders and their personnel should do whatever is possible to avoid appearing as an invading, alien force. While riot control personnel should be visible, force concentrations which might tend more to excite than to calm should be avoided where possible. Personnel must be civil; epithets and degrading language will not be used.

b. In applying the "application of force" principle, many and varied options as to how the troops may be armed are open to the commanders. The following options have been provided as guidance for determining how troops may be armed while applying one of the force measures:

<u>RIFLE</u>	<u>BAYONET SCABBARD</u>	<u>BAYONET</u>	<u>AMMUNITION MAGAZINE/ CLIP</u>	<u>CHAMBER</u>
At Sling	On Belt	In Scabbard	In Pouch On Belt	Empty
At Port	On Belt	In Scabbard	In Pouch On Belt	Empty
At Port	On Bayonet	Fixed	In Pouch On Belt	Empty
At Port	On Belt	Fixed	In Pouch On Belt	Empty
At Port	On Belt	Fixed	In the Weapon	Empty
At Port	On Belt	Fixed	In the Weapon	Round Chambered

These options are not sequential nor must any one follow the other. Use of a riot control agent in conjunction with any of the above options or by itself is an alternative also open to the commander on the scene.

c. Authority to order the use of the riot control agents rests with the task force commander. The task force commander may delegate this authority to commissioned officers. Riot control agents should be used to accomplish the mission before live ammunition is used.

UNCLASSIFIED

~~CONFIDENTIAL~~

APPENDIX 9 (SPECIAL INSTRUCTIONS) TO ANNEX C (CONCEPT OF OPERATIONS)  
TO DEPARTMENT OF THE ARMY CIVIL DISTURBANCE PLAN (U)

76

d. Military personnel will not load or fire their weapons except when authorized by an officer in person; when authorized in advance by an officer under certain specific conditions; or when required to save their lives.

e. The use of force to prevent sniping, arson, and looting and to detain persons caught in these acts may become necessary. The amount of force which may be used is that which is reasonably necessary under the circumstances. Warning shots will not be fired; however, when shooting is necessary, shots will be aimed to wound rather than to kill.

- (1) The normal reflex action of the well-trained combat soldier to sniper fire is to respond with an overwhelming mass of fire power. In a civil disturbance situation this tactic endangers innocent people more than snipers. The preferred tactic is to enter the building from which sniper fire originates. Darkening the street in order to gain protection from sniper fire is counterproductive. The following general approach should be emphasized in dealing with snipers.
  - (a) Surround the building where sniper is concealed and gain access, using armored personnel carriers if necessary and available.
  - (b) Employ CS initially rather than small arms fire. If CS is not successfully employed, then use well-aimed fire by expert marksmen.
  - (c) Illuminate the area during darkness.
- (2) The prevention of arson requires immediate and decisive action. Troops committed to civil disturbance control operations must continuously be on the alert for acts of arson or suspected arsonists. Immediate measures must be taken to eliminate or reduce this threat in the affected area by using the minimum force necessary to (1) prevent the arson and (2) apprehend the arsonist. Weapons fire may be required to prevent acts of arson which would cause loss of human life or destruction of facilities vital to public safety and the conduct of government. In such instances the principle of using only that force necessary must be observed and commanders should make every effort to control personally weapons fire directed at arsonists.

C-9-2

UNCLASSIFIED

~~CONFIDENTIAL~~



~~CONFIDENTIAL~~

UNCLASSIFIED

77

APPENDIX 9 (SPECIAL INSTRUCTIONS) TO ANNEX C (CONCEPT OF OPERATIONS)  
TO DEPARTMENT OF THE ARMY CIVIL DISTURBANCE PLAN (U)

- (3) Looters present a particular problem since women and children may be involved and the articles looted may be of little value. The looter is not necessarily sympathetic toward the views of those who otherwise participate in the disturbance. There is no satisfactory predetermination as to when firearms should be employed to stop looting beyond continued emphasis on the absolute necessity of using minimum force and avoiding the use of firearms except as a last resort and under the rules established here and in paragraphs d and e above.

2. (C) APPREHENSION

All arrests should be made, if possible, by the civil police. Where possible, police and military forces will be jointly employed in riot control operations so that police will be readily available to arrest people detained by military personnel.

3. (U) SPECIAL ORDERS

a. During required riot training all designated components of the U.S. Army, Navy, Air Force, and Marine Corps will be given familiarization training in the following "Special Orders:"

- (1) I will always present a neat military appearance. I will conduct myself in a military manner at all times and I will do all I can to bring credit upon myself, my unit, and the Military Service.
- (2) I will be courteous in all dealings with civilians to the maximum extent possible under existing circumstances.
- (3) I will not load or fire my weapon except when authorized by an officer in person, when authorized in advance by an officer under certain specific conditions, or when required to save my life.
- (4) I will not intentionally mistreat civilians, including those I am controlling, or those in my custody nor will I withhold medical attention from anyone who requires it.
- (5) I will not discuss or pass on rumors about this operation.

C-9-3

~~CONFIDENTIAL~~

UNCLASSIFIED

APPENDIX 9 (SPECIAL INSTRUCTIONS) TO ANNEX C (CONCEPT OF OPERATIONS)  
TO DEPARTMENT OF THE ARMY CIVIL DISTURBANCE PLAN (U)

78

- (6) I will to the maximum extent possible let civilian police arrest civilians, but when assistance is necessary or in the absence of the civilian police, I have the responsibility and authority to detain or take into custody rioters, looters, or others committing offenses. I will take such persons to the police or designated military authorities as soon as possible. It is my duty to deliver evidence and to complete evidence tags and detainee forms in accordance with my instructions.
- (7) I will allow properly identified reporters and radio and television personnel freedom of movement, unless they interfere with the mission of my unit.
- (8) I will avoid damage to property as far as possible.

b. The intent of these special orders is to strike a balance in the use of force so as to avoid indiscriminate firing in civil disturbance situations and that of protecting the individual's inherent right of self defense.

c. All personnel will possess a copy of the special orders while engaged in civil disturbance operations. Copies will be stockpiled at appropriate locations to facilitate expeditious distribution.

79

ANNEX D (LOGISTICS) TO DEPARTMENT OF THE ARMY CIVIL DISTURBANCE  
PLAN (U)

References:

- a. JCS Pub 3
- b. Annex K (Logistics) to Army Strategic Capabilities Plan (U)
- c. AR 1-35, Basic Policies and Principles for Interservice Support (SECNAV INST 4000.20, AFR 400-27, dated 2 Feb 68, with DOD Directive 4000.19 as an appendix).

1. SITUATION

Basic Plan:

- a. Dissident forces. Annex B (Intelligence).
- b. Federal and state forces. Basic Plan.
- c. Attachments and detachments. Annex A (Task Organization, Forces and Reaction Times).
- d. Assumptions, Basic Plan.

2. MISSION

To establish logistic responsibilities and provide logistic planning guidance for US forces in preparation for and/or subsequent deployment to conduct civil disturbance operations.

3. TASKS FOR SUBORDINATE HEADQUARTERS

a. Concept of Operations:

- (1) Forces will deploy from home station with accompanying supplies; each force will be self sustaining to the maximum extent possible. Resupply will be as directed by CGUSCONARC with maximum reliance on deployment area sources of supply in order to reduce airlift requirements.
- (2) Current applicable logistics policies and directives will apply unless otherwise directed herein or by subsequent directives.

ANNEX D (LOGISTICS) TO DEPARTMENT OF THE ARMY CIVIL DISTURBANCE  
PLAN (U)

80

- (3) Normal logistic support of committed forces for common items will be furnished from Army resources by the use of interservice support agreements and on a reimbursable basis. Service peculiar items will be supported through normal channels of the parent Service.

b. CGUSCONARC will insure that requests for logistics assistance from adjacent CONUS armies at or near disturbance areas are expeditiously handled.

4. MATERIEL AND SERVICES

a. Accompanying Supplies and Equipment. Initial logistic support will be provided by home stations of civil disturbance forces. CGUSCONARC/CINCARSTRIKE and CGUSASTRATCOM will prescribe detailed guidance on accompanying supplies and equipment. A suggested list is at appendix 1 for forces excluding USASTRATCOM detachments.

b. Supply Support:

- (1) When requested, USAMC will send a Customer Assistance Team to the task force headquarters in the objective area.
- (2) CGUSCONARC/CINCARSTRIKE will prescribe resupply policy and procedures. A suggested outline of resupply policy is at appendix 2.
- (3) Existing and/or new inter/intra service support agreements will be used to the maximum extent necessary.
- (4) Procurement assistance will be provided the task force by the CONUS Army commander responsible for supporting the objective area.

c. Services:

81

ANNEX D (LOGISTICS) TO DEPARTMENT OF THE ARMY CIVIL DISTURBANCE  
PLAN (U)

- (1) Maximum consideration will be given to contracting for services and/or resources in the objective area if like military support is not reasonably available, would be more costly to provide, or would not be timely or responsive. Contracted agreements must meet the mission requirements of the task force commander.
  - (2) Class II installations will provide such services as are readily available.
  - (3) Service support guidance, appendix 3, this annex.
- d. Pre-positioned equipment and munitions, appendix 4, this annex.
  - e. Loan and return of civil disturbance equipment, annex K.

5. MISCELLANEOUS

- a. Reports. Annex J.
- b. Conservation of Supplies. Only supplies necessary to support the operation should be provided. Supplies and equipment in the objective area will be safeguarded in order to prevent their destruction or unauthorized use.

- Appendixes:
- 1 - Suggested Accompanying Supply and Equipment List
  - 2 - Resupply Policy
  - 3 - Service Support Guidance
  - 4 - Pre-positioned Equipment and Munitions

SECRET

CONFIDENTIAL



~~CONFIDENTIAL~~

UNCLASSIFIED

83

APPENDIX 1 (SUGGESTED ACCOMPANYING SUPPLY AND EQUIPMENT LIST)  
TO ANNEX D (LOGISTICS) TO DEPARTMENT OF THE ARMY CIVIL DISTURBANCE  
PLAN (U)

1. (U) CLASS I

Three days operational rations.

2. (C) CLASSES II, IV, VII, VIII, IX

a. Fifteen days expendable supplies and repair parts.

b. Support unit's mission load of repair parts - 15 days.

c. Unit TOE/TD mess equipment, to include repair parts on hand at deployment time.

d. Armor, body, fragmentation protective. Basis of issue for Active Army as contained in Common Table of Allowances 50-901, Clothing and Equipment (PEACE). Basis of issue for Reserve components: 1 per 5 individuals.

e. Mask, protective field.

f. Individual weapons with bayonet knife.

g. M-60 machine gun, as authorized.

h. Launcher, Grenade, M-76 for M-14 rifle or launcher, grenade, M7A3 for M-1 rifle. Four per company when forces are not equipped with the M-79 grenade launcher. Airborne units committed, but not equipped with sufficient M-14 rifles and M-76 launchers, will be provided these items prior to deployment by the parent Army.

i. Launcher, Grenade, M79.

j. Dispenser, Riot Control Agent, Portable M3: one per company if forces of battalion size or larger are committed. Dispenser M106 is authorized for issue in lieu of Dispenser M3 when that item is not available from USAMC assets.

k. Dispenser, Riot Control Agent, helicopter or vehicle mounted, M5: one per battalion or brigade force committed.

l. Mask, Protective, Aircraft, M24: three per helicopter equipped with the M5 Riot Control Dispenser.

D-1-1

UNCLASSIFIED

~~CONFIDENTIAL~~

UNCLASSIFIED

84

APPENDIX 1 (SUGGESTED ACCOMPANYING SUPPLY AND EQUIPMENT LIST)  
TO ANNEX D (LOGISTICS) TO DEPARTMENT OF THE ARMY CIVIL DISTURBANCE  
PLAN (U)

m. Compressor, AN-M4, 3½ CFM: one per brigade or battalion task force. (Compressor, M1A1, 7 CFM may be utilized in lieu thereof, if AN-M4 is not available. Support item for M3 and M5 Riot Control Dispersers).

n. Kit, Service, Portable Riot Control M-27: 1 per brigade or battalion task force. Support item for M3 and M5 Riot Control Dispersers.

o. Except as provided above, only minimum mission essential Table of Organization and Equipment (TOE), Table of Allowance (TA), and individual equipment will be deployed.

p. Vehicles larger than 1½ ton airlifted into the objective areas will be held to an absolute minimum and will be limited to those which have been modified for special purpose use; i.e. signal, mess, and maintenance and are essential to accomplishment of the mission.

q. Special riot control items authorized by Basis of Issues (BOIs) furnished by DA.

3. (U) CLASSES III and IIIA

Vehicle tanks, organic tankers and gas cans full for surface movement. Vehicle tanks ¾ full, and gas cans full for air movements.

4. (C) CLASS V

Authorized quantities.

a. Weapons:

- (1) 60 rounds per rifle.
- (2) 800 rounds per M-60 MG.
- (3) 21 rounds per .45 caliber pistol.
- (4) 18 rounds per .38 caliber pistol.
- (5) 10 rounds 12 gauge 00 Buckshot per shotgun.

b. Bulk allotment items per company:

- (1) 208 ea grenade, hand, riot, CS M7A3.

UNCLASSIFIED

~~CONFIDENTIAL~~



85

APPENDIX 1 (SUGGESTED ACCOMPANYING SUPPLY AND EQUIPMENT LIST)  
TO ANNEX D (LOGISTICS) TO DEPARTMENT OF THE ARMY CIVIL DISTURBANCE  
PLAN (U)

- (2) 200 ea grenade, hand riot, CS1, M25A2.
- (3) 48 ea grenade, hand smoke, white, HC, AN-M8.
- (4) 208 ea cartridge, grenade-rifle, 7.62 mm., M64.
- (5) 208 ea adapter, grenade, projection-chemical, M2A1.
- (6) Cartridge, 40 mm., Riot Control, CS, E24: 20 per company not to exceed 200 per brigade.

c. Bulk allotment items per item of equipment.

- (1) 64 pounds riot control agent, CS1 per Dispenser, Riot Control, Portable, M3. (M106)
- (2) 240 pounds riot control agent, CS1 per Dispenser, Riot Control, helicopter or vehicle mounted, M5.

d. Ammunition items listed above which require installation stockage of quantities over and above the approved unit TOE basic load will be obtained using normal procedures. Project codes assigned in paragraph 1a, appendix 2, this annex, will be used for this purpose.

e. Minor deviations may be made to allow for differences in packaging.

5. (U) CLASS VI and X

Not applicable.

6. (U) SPECIAL ITEMS

- a. Camera, polaroid.
- b. Concertina wire with stakes.
- c. Launcher, grenade 40 mm.
- d. Public address system, either individual hand-held type (Bullhorn) or vehicle mounted type.

APPENDIX 1 (SUGGESTED ACCOMPANYING SUPPLY AND EQUIPMENT LIST)  
TO ANNEX D (LOGISTICS) TO DEPARTMENT OF THE ARMY CIVIL DISTURBANCE  
PLAN (U)

86

e. Searchlights suitable for ground vehicle or aircraft mounting.

f. Sniper rifle with scope.

g. Shotgun, 12 guage, Riot Type: 20 inch barrel.

~~CONFIDENTIAL~~ UNCLASSIFIED

87

APPENDIX 2 (RESUPPLY POLICY) TO ANNEX D (LOGISTICS) TO  
DEPARTMENT OF THE ARMY CIVIL DISTURBANCE PLAN (U)

1. (C) GENERAL

a. The following project codes will be assigned to identify Class V issues to forces indicated prior to implementation of GARDEN PLOT:

- (1) FPM - State Security Forces (National Guard under state control).
- (2) FPN - Active Army forces.
- (3) FPO - USAR forces.
- (4) FPP - USAMC installations.

b. Project Codes for all classes of supply required in the objective area are assigned and controlled by USAMC. A single project code to be used for all classes of supplies required in the objective area during the alert phase or after forces are committed will be provided by USAMC. Project codes for objective areas will be provided to the CONUS and MDW or task force commander upon telephonic request to the following appropriate member:

- (1) Duty Hours: AMC Operations Center  
AC 202, OXford 50451/2/3  
AUTOVON 555-3390
- (2) Non-duty Hours: AMC Staff Duty Officer  
AC 202, OXford 74206  
AUTOVON 555-3390

c. Emergency resupply of Army items beyond the capability of the supporting Army commander to resolve may be made to above telephone numbers at any time in the course of a civil disturbance operation.

d. An "03" priority will be used on all requisitions submitted for supplies or equipment required for mission accomplishment by a committed task force. Requisitions for supplies or equipment required for mission accomplishment by uncommitted civil disturbance forces will contain the issue priority designator commensurate with the Force Activity Designator assigned and the urgency of need.

D-2-1

~~CONFIDENTIAL~~ UNCLASSIFIED

UNCLASSIFIED

~~CONFIDENTIAL~~

APPENDIX 2 (RESUPPLY POLICY) TO ANNEX D (LOGISTICS) TO  
DEPARTMENT OF THE ARMY CIVIL DISTURBANCE PLAN (U)

2. (U) CLASS I

a. Field Ration "A" will be provided forces by USCONARC as soon as possible after arrival in the objective area.

b. Basic Daily Field Allowance Monetary (BDFAM) is authorized only when it is not practical or feasible to use Field Ration "A" or operational ration.

3. (U) CLASS II, IV, VII, VIII, and IX

a. In accordance with procedures established by USCONARC.

b. Cross-servicing as appropriate will be utilized to the maximum extent.

4. (U) CLASS III

a. Military sources, to include cross-servicing arrangements, will be exploited initially if readily available.

b. Credit cards as required will be provided committed forces by the CONUS Army commander.

c. Bulk purchases from commercial sources are authorized when military sources are not available.

5. (C) CLASS V

a. Small arms ammunition provided by USCONARC.

b. Riot control munitions:

(1) Requisitions will be directed to the U. S. Army Ammunition Procurement and Supply Agency (APSA) by the fastest possible means; confirm in writing. An emergency supply of riot control grenades for committed forces has been earmarked for purpose code "E" at the following AMC depots:

(a) Lexington-Blue Grass Depot, Lexington, Kentucky in support of First and Third Army Areas and MDW.

(b) Pine Bluff Arsenal, Pine Bluff, Arkansas, in support of Fourth and Fifth Army Areas.

UNCLASSIFIED

~~CONFIDENTIAL~~

~~CONFIDENTIAL~~

UNCLASSIFIED

89

APPENDIX 2 (RESUPPLY POLICY) TO ANNEX D (LOGISTICS) TO  
DEPARTMENT OF THE ARMY CIVIL DISTURBANCE PLAN (U)

- (c) Tooele Army Depot, Tooele, Utah, in support of Sixth Army Area.
  - (2) Requests for release of the emergency supply of grenades will be made to the ICP (USAAPSA) and not to the depot. When an emergency resupply situation does not exist, normal replenishment actions will be accomplished.
6. (U) CLASS VI and X
- Not applicable.

D-2-3

~~CONFIDENTIAL~~ UNCLASSIFIED

CONFIDENTIAL

91

APPENDIX 3 (SERVICE SUPPORT GUIDANCE) TO ANNEX D (LOGISTICS) TO  
THE DEPARTMENT OF THE ARMY CIVIL DISTURBANCE PLAN (U)

1. LAUNDRY

As an exception to paragraph 28b, AR 210-130 where task forces are deployed from their home stations to engage in the control of civil disturbances, authority is granted to provide laundry services at Government expense. This authority is limited to military personnel of the Active Army, the National Guard when called and the Army Reserve when mobilized. Military personnel of the other Services who meet the above cited criteria regarding engagement in the control of civil disturbances are also eligible. Service will be provided at Government facilities (Army, Navy, Air Force, and Marine Corps) when available through this source or in their absence by commercial contractual arrangements. OMA cost code 9040.5300 will be cited to cover and absorb the cost for Army personnel when service is by commercial contract or Government laundries other than Army operated facilities. Service provided by Army operated facilities to Army personnel will be chargeable against OMA funds and specifically to the laundry program cost code 9040.5. When service is provided to military personnel other than Army, the Service from which the personnel is detailed will support the costs incurred.

2. BATH

- a. Provided by nearest military installation if practicable.
- b. Provided by mobile bath or decontamination units if available.
- c. If military facilities are not available, universities, high schools, armories, and recreational facilities will be utilized after necessary coordination.

3. MAINTENANCE

- a. Task force elements will perform maximum organizational maintenance on their organic equipment.
- b. USCONARC will provide direct and general support maintenance for task force elements in the objective area as required, to include prompt initiation of contract or inter/intra service agreements with other Governmental agencies if required.

D-3-1

APPENDIX 3 (SERVICE SUPPORT GUIDANCE) TO ANNEX D (LOGISTICS) TO  
DEPARTMENT OF THE ARMY CIVIL DISTURBANCE PLAN (U)

92

c. USCONARC will stress operator maintenance training in task force units to attain a high state of materiel readiness.

d. Maximum use will be made of maintenance support capability of Class I installations for support of task force units.

e. Mobile maintenance contact teams, as required, are encouraged to establish liaison with task force headquarters to determine maintenance support requirements and to coordinate and expedite maintenance efforts in support of the task force.

f. Intermediate (direct/general) and depot level maintenance will continue to be a responsibility of the parent Service.

4. ENGINEER

a. Real Estate

- (1) USCONARC will provide field personnel to permit rapid and efficient execution of operations under this plan. Use agreements for known task force facility requirements may be executed by the appropriate Division/District Engineer on request by the Army commander. If considered necessary by the Army commander and with the concurrence of the appropriate civil authorities, arrangements providing for use of facilities may be concluded as a planning action in preparation for potential operations under this plan. Requirements that real estate actions be handled insofar as practicable on a need-to-know basis, without publicity, are not considered to prohibit establishment of necessary real estate arrangements, either before or after initiation of operations under this plan. Although US Army Division/District Engineers are responsible for the acquisition of real estate requirements, responsibility for the release of any information concerning a plan or change in an existing plan is with the Army commander or his designee. Therefore, initial contacts with public officials or private property owners for the use of real property will be made by the Army commander or his designee. The Division/District Engineer, or his real estate representative may accompany the Army commander's representative to provide technical support.



93

APPENDIX 3 (SERVICE SUPPORT GUIDANCE) TO ANNEX D (LOGISTICS) TO  
DEPARTMENT OF THE ARMY CIVIL DISTURBANCE PLAN (U)

- (2) The staff of each task force will include an officer to coordinate real estate matters through and in conjunction with the responsible CONUS Army engineer.
- (3) In developing implementing plans, task force commanders will make maximum use of Federally controlled property.
  - (a) Property under DOD control. Direct coordination is authorized with all elements of DA, DN, and DAF for permission to use Army, Navy, Air Force, or Marine Corps controlled property.
  - (b) Property controlled by other Federal agencies and non-Federally controlled property.
    1. Real estate operations will be coordinated by the United States Army Engineer Division/District which performs military construction and real estate operations in the applicable area.
    2. The Division/District engineers will advise the Army task force commander on required procedures prior to reconnaissance and occupancy of property not under DOD control.
    3. Direct coordination with the US Army Division/District engineer should be maintained for real estate matters and to keep the Division and District engineers informed on civil disturbance task force requirements.
- (4) Requests by the National Guard when employed under State control for the use of active Army and USAR facilities can be approved or disapproved at CONUSA/MDW level except when such operations would be in violation of Federal statutes. Licensing of USAR facilities for periods of occupancy will include a provision for dual occupancy (USAR and NG).

b. Construction. Where facilities are not available from local sources and construction must be accomplished, austere constructions standards will be used to meet minimum essential requirements.

APPENDIX 3 (SERVICE SUPPORT GUIDANCE) TO ANNEX D (LOGISTICS) TO  
DEPARTMENT OF THE ARMY CIVIL DISTURBANCE PLAN (U)

94

c. Utilities.

- (1) Electric power will be provided from existing real property facilities only excluding USASTRATCOM detachments. Additional requirements will be provided by organic power units.
- (2) Water will be from approved sources only. Coordination will be effected through the Logistics Liaison Team (LLT).
- (3) Sanitation will be through use of local sanitation facilities wherever possible. Coordination for additional facilities will be through the LLT.

5. TRANSPORTATION

a. Movement requirements to deploy civil disturbance forces will be submitted as follows:

- (1) Navy, Air Force and Marine Corps troop listed units will submit requirements in excess of organic capability to move their forces to and from objective areas and/or departure airfields to CGUSCONARC.
- (2) USCONARC will submit movement requirements for all active forces assigned to this plan to DA, DCDPO, ATTN: CDPO-OPS-M.
- (3) Army forces not under control of USCONARC will be submitted to USCONARC (e.g., USASTRATCOM detachments).
- (4) National Guard forces that are not Federalized will deploy by using state resources.

b. DCDPO will task the Department of the Air Force for airlift and MTMTS for surface movement to provide necessary transportation in support of GARDEN PLOT movement requirements.

c. Transportation support plans will be prepared and processed for all units assigned to this plan so that specific type forces by geographic area can be identified and air/surface requirements identified. Movement data will be submitted and processed in accordance with the Deployment Reporting System (DEPREP). Movement requirements arising during a civil disturbance or when a unit is alerted, and not processed in accordance with DEPREP will

95

APPENDIX 3 (SERVICE SUPPORT GUIDANCE) TO ANNEX D (LOGISTICS) TO  
DEPARTMENT OF THE ARMY CIVIL DISTURBANCE PLAN (U)

be passed by USCONARC to DA/Civil Disturbance Command Center (CDCC) telephonically and confirmed by Priority message.

d. Organic transportation will be utilized to the fullest extent in the disturbance area. Surface transportation will be used for movement of contiguous units to the disturbance area as well as the movement of incoming units from arrival airfields. Sources of surface transport by priority are:

- (1) Contiguous Active Army/Navy/Air Force/Marine Corps equipment.
- (2) Local Active Army/Navy/Air Force/Marine Corps installation motor pools.
- (3) USAR unit equipment.
- (4) NGUS unit equipment.
- (5) Other Governmental agencies.
- (6) Commercial equipment.

e. Transportation requirements in the disturbance/deployment area which are beyond task force capability will be reported to the headquarters having responsibility for logistic support.

f. Redeployment movement requirements will be submitted by task force commanders through USCONARC to DA, ATTN: CDPO-OPS-M.

g. Unless otherwise directed, aircraft will be loaded during deployment/redeployment operations to insure maximum use of aircraft allowable cargo load (ACL).

h. Movement requirements and reporting as prescribed in appendix 13, annex J.



97

APPENDIX 4 (PRE-POSITIONED EQUIPMENT AND MUNITIONS) TO ANNEX D  
(LOGISTICS) TO DEPARTMENT OF THE ARMY CIVIL DISTURBANCE PLAN (U)

1. PRE-POSITIONED EQUIPMENT

Requesting/releasing procedures:

a. All approved requests for release of this equipment will be forwarded to DA/CDCC and will be in RCS JCS 1053 report format and identified as a ROAD JUNCTION request.

b. Requirement will be placed directly on the depot by HQ, USAMC after DA approval.

2. PRE-POSITIONED MUNITIONS

Requesting/releasing procedures. Requests for release of this emergency supply of grenades will be made to the ICP (APSA).

3. OTHER SUPPLIES

a. Normal resupply procedures will be used when an emergency situation does not exist.

b. When an emergency precludes the use of normal supply procedures, the task force commander will:

- (1) Request assistance from the Customer Assistance Team assigned to the objective area; or:
- (2) Telephone his request direct to the appropriate commodity supply manager:
  - (a) NICP for Army-managed items.
  - (b) Defense Supply Centers for DSA-managed items.
  - (c) General Services Regional Offices for GSA-managed items.
- (3) Provide as much of the following information as he has available:
  - (a) Units involved.
  - (b) Ship to address.

D-4-1

APPENDIX 4 (PRE-POSITIONED EQUIPMENT AND MUNITIONS) TO ANNEX D  
(LOGISTICS) TO DEPARTMENT OF THE ARMY CIVIL DISTURBANCE PLAN (U)

98

- (c) Nomenclature.
- (d) FSN for each item requested.
- (e) Quantity.
- (f) Fund Code.
- (g) Priority (all requisitions under this OPLAN are "03").
- (h) Project Code.
- (i) Signal Code.
- (j) Shipping Instructions, if known.
- (k) Transportation Details.

c. The appropriate commodity manager will effect release of the materiel and direct the appropriate depot to ship in accordance with instructions furnished.

ITEMS SCHEDULED FOR PRE-POSITIONING

Pre-positioned Equipment

	<u>Tooele</u>	<u>Pine Bluff</u>	<u>Lexington</u>
Mask, Protective M-9	20,000	20,000	20,000
Dispenser, Riot Control Agent M-3*	40	40	40
Dispenser, Riot Control Agent M-5	3	3	3
Compressor, AN-M4	14	14	14
Kit, Service M-27	14	14	14

\*Dispenser, M106 may be issued in lieu of M-3 dispenser.

99

APPENDIX 4 PRE-POSITIONED EQUIPMENT AND MUNITIONS) TO ANNEX D  
(LOGISTICS) TO DEPARTMENT OF THE ARMY CIVIL DISTURBANCE PLAN (U)

	<u>Pre-positioned Munitions</u>		
	<u>Tooele</u>	<u>Pine Bluff</u>	<u>Lexington</u>
Cartridge, 40 mm, E24	5,000	5,000	5,000
Grenade, Hand CS1, M25A2	30,000	30,000	30,000
Grenade, Hand CS M7A3	30,000	30,000	30,000
Riot Control Agent CS (lbs)	20,000	20,000	20,000

	<u>Pre-positioned Communications Equipment</u>		
	<u>Lexington</u>	<u>Sacramento</u>	<u>Tobyhanna</u>
Public Address Set AN/PIQ5A	40	30	30
Search Light, Zenon AN/MSS3	12	12	-
Communications Packet, Bn	8	8	4
Communications Packet, Bde	2	2	2
Communications Packet, Div	1	1	-





101

ANNEX E (PERSONNEL) TO DEPARTMENT OF THE ARMY CIVIL DISTURBANCE  
PLAN (U)

References:

- a. JCS Pub 3.
- b. DA Pamphlet 27-11.
- c. AR 40-2.
- d. AR 40-3.
- e. AR 40-535.
- f. AR 135-20.
- g. AR 135-300.
- h. AR 330-12.
- i. AR 335-60.
- j. AR 600-10.
- k. Appropriate publications of other Services.

1. INTRODUCTION

This annex establishes personnel responsibilities and planning guidance for forces deploying to conduct operations set forth in the basic plan.

2. MEDICAL SERVICES

Appendix 1, this annex.

3. PERSONNEL

- a. Strength accountability is a Service responsibility.
  - (1) Active Army Units. Current reporting procedures will apply to Active Army units employed in accordance with this plan.
  - (2) Called Army National Guard Units and Reserve units ordered to active duty (AR 135-300).
    - (a) Units will prepare and submit an initial morning report as prescribed by paragraph 2-37, AR 135-300.

ANNEX E (PERSONNEL) TO DEPARTMENT OF THE ARMY CIVIL DISTURBANCE  
PLAN (U)

102

- (b) The strength accountability for members entering on active duty with these units will be governed by AR 330-12.
  - (c) All subsequent morning reports will be prepared in accordance with AR 335-60.
  - (d) Final morning reports will be submitted in accordance with AR 335-60 when units are relieved from active duty.
- b. Casualty notification is a Service responsibility.
- (1) Casualty notification for Active Army and Army National Guard personnel called into active Federal service will be as prescribed in AR 600-10.
  - (2) Casualty notification of Army National Guard personnel ordered to state active duty will be made in accordance with NGR 28.
- c. Personnel Status Report (annex J).
- d. Replacements:
- (1) Maintenance of force strengths of units is a Service responsibility. Units will deploy from home stations with all authorized personnel except that firemen and law enforcement personnel may be exempted when their services are needed at home stations because of the threat of civil disturbances.
  - (2) Active Army requisitions will be submitted in accordance with AR 614-202 or AR 614-185, as appropriate.
  - (3) Reserve components of the Armed Forces on active duty will requisition replacements from active Service Personnel resources to replace losses incurred.
  - (4) Procedures for termination of call into Federal service and order to active duty is a Service responsibility.
    - (a) Upon receipt of a notification of termination of the call into Federal service and the order to active duty, commanders of units having active Army replacements will immediately report such personnel for reassignment instructions through appropriate Army Area commanders to Chief of Personnel Operations, Headquarters, Department of the Army, Washington, D. C. 20310, ATTN: Career Branch for commissioned

103

ANNEX E (PERSONNEL) TO DEPARTMENT OF THE ARMY CIVIL DISTURBANCE  
PLAN (U)

officers and warrant officers; and EPADS for enlisted personnel in pay grades E7 through E9, Intelligence and special category personnel, and ATTN: EPADR-I for other enlisted personnel.

- (b) Administrative Instructions for Release of called Army National Guard Personnel and Army Reserves ordered to active duty (AR 135-20, Release from Active Duty Reserve Components, 1968).

e. Morale and Welfare. Morale and welfare support is a Service responsibility. USCONARC is responsible for support of assigned Army forces prior to deployment, during movement, and forces from all Services in the objective area(s), and will assure:

- (1) Assistance for dependents of deployed personnel as required.
- (2) Mail service is continued for deployed units.
- (3) Post exchange facilities and motion picture services support will be provided as appropriate. Direct contact by USCONARC with the Chiefs, AAFES and AAFMPS and subordinate elements thereof, is authorized for the purpose of developing and executing plans for exchange and motion picture support.
- (4) Special Services activities to include advance recreational programming, and stockpiling of selected supplies and equipment in strategic locations is accomplished.
- (5) Policies and procedures regarding the following areas will be incorporated in operation plans:
  - (a) Finance.
  - (b) Leave and Passes.
  - (c) American Red Cross.
  - (d) Decorations and Awards.
  - (e) Legal Assistance.
  - (f) Religious Services.

ANNEX E (PERSONNEL) TO DEPARTMENT OF THE ARMY CIVIL DISTURBANCE  
PLAN (U)

104

- (g) Recreational activities to include use of stock-piled supplies and equipment.
  - (h) Free 16mm motion picture service.
  - (6) Unit (site) Exchange Officers are appointed and site exchanges operated in accordance with AR 60-34, if required.
  - (7) Welfare funds are requested in accordance with paragraph 30.1, Change 9, AR 230-10, if required.
  - (8) Chaplain support for force personnel will be sufficient to provide normal coverage. Chaplain support for detained civilians will be limited to emergency ministrations.
- f. Processing of Nonmilitary Evacuees.
- (1) USCONARC plans should include provisions for utilization of nonmilitary Government service organizations to the maximum extent practicable in processing and handling of evacuees during civil disturbance operations.
  - (2) Plans for use of military resources will be contingent upon inability of nonmilitary organizations to provide these services and will specify resumption of nonmilitary control and assistance at the earliest practicable time.
  - (3) Coordination is authorized at the local level with Service organizations for planning purposes as required.
- g. Detention:
- (1) As a matter of policy, Federal forces will be utilized for civilian detention operations only in cases of absolute necessity. Primary responsibility for civilian detention operations rests with local and state law enforcement agencies and Federal agencies such as the Department of Justice.
  - (2) Civil disturbance contingency plans governing the employment of Federal forces will include provisions for providing detention assistance to civilian authorities. Plans for this assistance will range

105

ANNEX E (PERSONNEL) TO DEPARTMENT OF THE ARMY CIVIL DISTURBANCE  
PLAN (U)

from the absolute minimum, such as assisting civil police in the guarding of civilians apprehended and awaiting transfer or enroute to detention facilities, to the establishment and operation of temporary detention facilities to supplement those operated by civil authorities. All such assistance will be predicated on the turnover of this responsibility to civil authorities as soon as practicable.

- (3) When Federal forces are required to detain civilian offenders in a military detention center during civil disturbance operations, DA Form 3316-R, 1 March 1968 (appendix 2) will be completed for each detainee regardless of where they are to be physically detained. This form will be locally reproduced and prestocked in sufficient quantity to satisfy estimated requirements. Detainee forms previously prepared in compliance with this plan will be used until current stocks are exhausted.
- (4) When Federal forces are required to establish and operate temporary detention facilities for any appreciable length of time, these facilities will normally be under the professional supervision and control of Army Military Police Corps personnel. To the extent feasible, the operation of these facilities will be in conformity with the spirit and intent of regulations and manuals which govern the operation of military confinement facilities.

h. Legal Matters.

- (1) Legal matters are a Service responsibility.
- (2) Claims: Task force commanders will assign responsibility for processing claims to judge advocates in the respective Services assigned to the Task Force Headquarters in accordance with current claims directives.
- (3) Court-Martial Jurisdiction: Upon the establishment of a task force, CONARC will attach called Army National Guard personnel, Army Reserves ordered to active duty, and appropriate Active Army task force personnel to a general court-martial jurisdiction within the Army Area concerned.
- (4) The Staff Judge Advocate of the CONUS Army concerned will be prepared to provide professional and clerical

ANNEX E (PERSONNEL) TO DEPARTMENT OF THE ARMY CIVIL DISTURBANCE  
PLAN (U)

106

assistance (1 Major, 1 Captain, and 2 enlisted men) to the OTJAG member of the DALT accompanying the PLOCSA in the objective area.

i. Foreign Trainees. Commanders of installations furnishing units under this plan will insure that foreign personnel present at these installations for training are not included in the units deployed in an operational, support or observer status.

Appendixes: 1 - Medical Support  
2 - Detainee Turnover Record

107

APPENDIX 1 (MEDICAL SUPPORT) TO ANNEX E (PERSONNEL) TO DEPARTMENT OF THE ARMY CIVIL DISTURBANCE PLAN (U)

References:

- a. JCS Pub 2.
- b. AR 40-2.
- c. AR 40-3.
- d. AR 40-121.
- e. AR 40-535.
- f. FM 19-15.
- g. Appropriate publications of other Services.

1. SITUATION

Basic Plan.

2. MISSION

To insure essential medical service to the civil disturbance areas when the Chief of Staff, US Army, is directed by the DOD Executive Agent to restore and maintain law and order in civil disturbance areas.

3. POLICIES

a. Primary reliance will be on civilian medical facilities to support civilian medical requirements.

b. Only that medical support essential to the prevention of undue suffering and prevention of loss of life or limb will be provided by military sources to augment the civilian capabilities.

c. Civilian casualties admitted to military hospitals will be transferred to civilian hospitals at the earliest time medically feasible.

d. Military members will be admitted to civilian hospitals only in an emergency.

e. Military members admitted to civilian hospitals will be transferred to military hospitals as soon as medically feasible.

APPENDIX 1 (MEDICAL SUPPORT) TO ANNEX E (PERSONNEL) TO DEPARTMENT  
OF THE ARMY CIVIL DISTURBANCE PLAN (U)

108

f. CGUSCONARC and designated commanders of the unified command(s) outside CONUS will coordinate the medical support requirements of subordinate units.

g. Requirements for medical support beyond the capability of commanders to provide or arrange, will be reported to Department of the Army.

h. Medical reports will be submitted as required.

i. Medical units and medical personnel providing medical support to military and other personnel in connection with civil disturbances, will be utilized in consonance with assigned missions and specialties. Medical personnel will wear the distinctive medical insignia (arm brassard) when performing medical duties. Equipment to be carried or worn by medical personnel will be prescribed by the commander concerned.



109

APPENDIX 2 (DETAINEE TURNOVER RECORD) TO ANNEX E (PERSONNEL) TO DEPARTMENT OF THE ARMY CIVIL DISTURBANCE PLAN (U)

~~FOR OFFICIAL USE ONLY~~

DETAINEE TURN		OVER RECORD
1. DETAINEE		3. WHO MADE DETENTION
NAME		NAME
ADDRESS		GRADE OR TITLE
DESCRIPTION		UNIT
2. WHAT DETAINEE DID		4. WHO ESCORTED DETAINEE TO DETENTION CENTER
DESCRIBE INCIDENT		NAME
		GRADE OR TITLE
		UNIT
WHEN DID INCIDENT OCCUR (Date and Time)		REMARKS:
WHERE DID INCIDENT OCCUR		

~~FOR OFFICIAL USE ONLY~~

E-2-1

~~FOR OFFICIAL USE ONLY~~

5. WITNESSES (Give name, grade or title if applicable and unit or address)	<p>DETAINEE TURNOVER RECORD</p> <p>This card will be filled out on each person detained and will be turned in at the Detention Center with the detainee. When possible, the person making the detention should do this. If this is not possible, the person designated to escort the detainee to the Detention Center will fill out the card (preferably before accepting the detainee), based on verbal information from the person making the detention.</p> <p>(Fold to fit in pocket)</p>
a	
b	
c	
6. WEAPONS AND ARTICLES REMOVED:	

E-2-2

~~FOR OFFICIAL USE ONLY~~

///

ANNEX F (INFORMATION) TO DEPARTMENT OF THE ARMY CIVIL DISTURBANCE PLAN (U)

References:

- a. AR 500-50.
- b. AR 360-5.
- c. AR 360-81.

1. SITUATION

Basic Plan

2. MISSION

a. To provide the public prompt and accurate information concerning the civil disturbance situation.

b. To insure that military personnel of the task forces are kept informed on the situation, their mission, duties and responsibilities, and their relationships with municipal authorities, the populace and the news media.

3. CONCEPT

a. Public affairs policy is to provide to the public, through cooperation with and service to news media representatives, prompt, responsive, and accurate information. Emphasis will be placed on the fact that the US Army has been assigned a mission, assisted by other Services as appropriate, to assist civil authorities in restoring and/or maintaining law and order and will carry out that mission using minimum force required.

b. A press room will be established. The press will not be furnished transportation and telephone service except in circumstances where the military is the only source capable of providing such accommodations. Minimum necessary equipment such as tables and chairs will be provided.

4. EXECUTION

a. General

- (1) The Assistant Secretary of Defense (Public Affairs) (ASD(PA)) is responsible for public release of material relating to civil disturbances and will designate on-site Department of Defense (DOD) Public Affairs Chiefs (PAC).

ANNEX F (INFORMATION) TO DEPARTMENT OF THE ARMY CIVIL DISTURBANCE  
PLAN (U)

112

- (2) A representative from OCINFO, DA, will be a member (Information Adviser) of the DA Liaison Team (DALT) that will accompany the Personal Liaison Officer of the Chief of Staff (PLOCSA) in the objective area.
- (3) A senior US Army Information Officer will be designated the task force information officer (TF/IO) for each task force.

b. Guidelines for Release of Information.

- (1) Prior to the issuance of the Presidential Proclamation and Executive Order directing Federal intervention in a civil disturbance situation:
  - (a) Military Departments will make no voluntary public statement concerning preparations for the operations.
  - (b) Queries concerning possible employment of military forces will be answered: "Department of Defense policy is not to comment on plans concerning the possible employment of military units and resources to carry out assigned missions."
- (2) An agency higher than the Department of the Army will make the initial news release announcing the President's decision to intervene in civil disturbances.
- (3) During the deployment from home stations, queries may be answered within the context of national releases. Queries which cannot be answered within these guidelines will be referred to CININFO, DA, for resolution by the fastest means available. The questioner will not be apprised of the referral to DA.
- (4) Public releases will be cleared by the DOD Public Affairs Chief in accordance with DOD Directive 3025.12, 8 June 1968.
- (5) During the redeployment of forces to home stations, information policies of CGUSCONARC will govern.
- (6) Information furnished the press will avoid conjecture concerning future operations.

c. Responsibilities:

113

ANNEX F (INFORMATION) TO DEPARTMENT OF THE ARMY CIVIL DISTURBANCE  
PLAN (U)

- (1) Chief of Information, Department of the Army (CINFO, DA).
  - (a) Provides Information Adviser (IA) to PLOCSA.
  - (b) Through the IA to the PLOCSA, monitors public and command information activities of the task force in the objective area.
  - (c) In consonance with DOD (PA) guidance, issues supplemental policy guidance as necessary to USCONARC and the task force commander.
- (2) Commanding General, US Continental Army Command (CGUSCONARC).
  - (a) Designates a senior Army Information Officer to serve as the task force information officer.
  - (b) Provides information personnel and equipment to augment the information office in the objective area as required by the task force commander. If required, consideration should be given to use of selected Reservists having an information background. The task force information officer should be provided the necessary equipment and facility to conduct a comprehensive public and command information effort on a 24-hour basis.
  - (c) Develops measures designed to insure that the troop orientation and daily troop briefings are given command emphasis. The initial briefing should be accomplished prior to departure from unit home station or as soon as possible thereafter.
  - (d) Provides psychological operations personnel and equipment to augment information office in the objective area as required by the task force commander. Insures readiness of loudspeaker teams, audio-visual teams, light mobile printing teams, and other PSYOPs specialist personnel and equipment required in support of the task force information officer.
- (3) Task Force Commander:
  - (a) Assigns the TF/IO as a member of the advance party to establish early coordination with DOD PAC, and IA

114

ANNEX F (INFORMATION) TO DEPARTMENT OF THE ARMY CIVIL DISTURBANCE PLAN (U)

to PLOCSA and other counterparts in the objective area (local police, National Guard).

- (b) Insures information personnel and equipment accompany the task force to the objective area to provide a capability of conducting information activities as described herein.
- (c) Insures that troop orientations are conducted prior to arrival in objective area (appendix 1, this annex).
- (d) As a means of keeping the troops informed, issues at least one unclassified fact sheet daily during the operation.
- (e) Insures that each subordinate task force headquarters (battalion size unit) has an information officer whose primary function will be the conduct of the unit command information program.
- (f) In coordination with the IA to the PLOCSA and the clearance policy described herein:
  - 1. Establish an information facility.
  - 2. Make news releases, concerning the military operations.
  - 3. Conduct press briefings.
  - 4. Coordinate press coverage of units including escorts.
  - 5. Answer press questions.
  - 6. Establish and maintain liaison with other public affairs/information agencies, military and civilian, for purposes of exchanging information and coordinating activities designed to keep the news media informed and to assist them to cover the operation.
  - 7. Provide photographic coverage of the operation for public information purposes.

115

ANNEX F (INFORMATION) TO DEPARTMENT OF THE ARMY CIVIL DISTURBANCE  
PLAN (U)

5. ADMINISTRATION

News media representatives will be allowed freedom of movement provided they do not interfere with the execution of the military mission. Press escorts will be provided by the task force information officer when required and available.

Appendix: 1 - Troop Orientation

00

00

00



117

APPENDIX 1 (TROOP ORIENTATION) TO ANNEX F (INFORMATION) TO  
DEPARTMENT OF THE ARMY CIVIL DISTURBANCE PLAN

A troop orientation is to be accomplished, when possible, prior to movement from home stations for employment in civil disturbance operations or as soon as possible thereafter. This orientation will include, but not be limited to:

a. The background of the situation to include the buildup of opposition and disturbances leading to the Presidential directive or order to employ Federal troops.

b. The specific mission of the unit.

c. The specific command structure for the operation to include commanders' names.

d. A review of the role of the serviceman in civil disturbances and the special orders contained in Appendix 9 (Special Instructions), Annex C (Concept of Operation) to the Department of the Army Civil Disturbance Plan.

e. Explanation that assigned duties should be executed firmly, but calmly, politely, and respectfully.

f. Action that must be taken to protect citizens and their property.

g. A description of identification normally used by news media representatives, including photographers. (Show personnel sample badges.)

h. A statement that no effort will be made to control news media representatives identified by badges in their access to public property as long as they do not interfere with the execution of the unit's mission.

i. Basic guidelines for responding to press:

(1) Unless specifically authorized by appropriate military authority, the serviceman should respectfully decline requests for his personal opinions about the disturbance. If the answer to a question is classified or if it might endanger the mission or those performing it, the serviceman should refer the questioner to his commanding officer or other appropriate authority.

(2) If the answer to a question would give such an incomplete picture of the overall operation that a false conclusion might be drawn, the serviceman should refer the questioner to a military superior for a more detailed answer.

F-1-1

ANNEX F (INFORMATION) TO DEPARTMENT OF THE ARMY CIVIL DISTURBANCE  
PLAN (U)

118

j. Explanation of the pass and leave policy and the reasons therefor.

k. Explanation of the importance of politely declining any requests to pose for news photographs.

~~CONFIDENTIAL~~

UNCLASSIFIED

119

ANNEX G (COMMUNICATIONS-ELECTRONICS) TO DEPARTMENT OF THE ARMY  
CIVIL DISTURBANCE PLAN (U)

1. (U) SITUATION

Basic Plan.

- (1) Dissident Elements: Annex B - Intelligence.
- (2) Federal and state forces: Basic Plan.
- (3) Task Organization, Forces and Reaction Times: Annex A.
- (4) Assumptions: Basic Plan.

2. (U) MISSION

To provide CONUS communications-electronics support for the Department of Defense components, Federal agencies and task forces committed to civil disturbance operations.

3. (C) EXECUTION

a. Concept of Communications-Electronics Support.

- (1) DA Command Control Communications. The primary means of communications from the CofSA/CDCC (DA Civil Disturbance Command Center) to the PLOCSA and the task force commander, will consist primarily of specially leased communications circuits and AUTOVON. Alternate communications will be provided by HF/SSB voice radio.
- (2) Task Force Communications. The primary means of communications for the task force will be leased communications circuits backed up by an intratask force tactical radio communications system supplemented by commercial FM voice radios and mobile telephone service (MTS) installed as a safeguard against the possible loss of leased communications circuits.
  - (a) A civilian car with installed mobile telephone service equipment will be available to the task force commander upon his arrival in an objective city. This equipment will enable the task force commander to establish immediate voice communications with the CofSA.

G-1

UNCLASSIFIED

~~CONFIDENTIAL~~

~~CONFIDENTIAL~~  
UNCLASSIFIED

ANNEX G (COMMUNICATIONS-ELECTRONICS) TO DEPARTMENT OF THE ARMY  
CIVIL DISTURBANCE PLAN (U)

120

- (b) Two Dataphones (603) will be carried into the objective city by the task force commander. This equipment will provide the task force commander with a capability to establish two point-to-point voice circuits to the CofSA/CDCC through the commercial telephone system until the standard communication packet becomes operational.
  - (c) A commercial FM voice radio system consisting of one base station and 20 portable radios, with a radio-wire integration (RWI) capability, will be carried into the objective city by the task force commander. This radio system will provide means to establish communications to CofSA/CDCC and provide a portable/mobile net for the task force commander and selected key personnel, such as the mayor in the objective area.
  - (d) Commercial radio receivers will be carried into the objective city by the task force headquarters. This equipment will provide the task force with the capability to monitor police radio nets.
  - (e) Portable tape recorders will be carried into the objective city by both the task force commander and PLOCSA. This equipment can be used for recording at any telephone instrument.
  - (f) A standard city wiring package consisting of minimum essential communications circuits will be available or will be installed by USASTRATCOM at the task force main command post (appendix 1, this annex).
  - (g) Additional leased communications circuits, both local and long distance, will be made available as requested (appendix 2, this annex).
  - (h) A switchboard will be installed by USASTRATCOM at the task force main command post.
- (3) Liaison communications between civilian law enforcement agencies and task force units. This will be accomplished by any of the following methods.
- (a) Collocation of military/civil command posts.

UNCLASSIFIED  
~~CONFIDENTIAL~~

~~CONFIDENTIAL~~ UNCLASSIFIED

121

ANNEX G (COMMUNICATIONS-ELECTRONICS) TO DEPARTMENT OF THE ARMY  
CIVIL DISTURBANCE PLAN (U)

- (b) Commercial telephone.
- (c) Exchange of equipment and personnel.
- (4) Augmentation C-E support for task force subordinate units.
  - (a) A selected amount of tactical communications equipment is available to augment the C-E capability of the Active Army and NG units, and Active and Reserve components assigned from the other Services, as required. This equipment is pre-positioned at designated locations for rapid delivery to requesting units.
  - (b) Locations and procedures for obtaining and returning the augmentation C-E equipment are shown at appendix 3, this annex.
- (5) Commercial Telephone Service. USASTRATCOM is the contracting authority for all leased commercial circuits. The procedures for obtaining leased commercial circuits are shown at appendix 2, this annex.
- (6) Audio-Visual Support. Audio-visual support will be available to major elements actively engaged in civil disturbance operations. This support will consist of two types: General audio-visual support to meet the requirements of the DA/CDCC and staff elements of DA generated anywhere within CONUS; and task force audio visual support to cover the requirements of the task force commander in his area of operations. This support will be accomplished by appropriate photographic teams as shown at appendix 4, this annex.
- (7) USASTRATCOM Detachment Deployment Concept. USASTRATCOM detachments will be alerted and deployed as follows:
  - (a) USASTRATCOM detachments normally will be on the same alert status as the IRE of the task force headquarters to be supported.
  - (b) When a task force commander is ordered on a reconnaissance mission, a USASTRATCOM detachment will be dispatched to the objective area concerned.

G-3

UNCLASSIFIED

~~CONFIDENTIAL~~

~~CONFIDENTIAL~~  
UNCLASSIFIED

ANNEX G COMMUNICATIONS-ELECTRONICS) TO DEPARTMENT OF THE ARMY  
CIVIL DISTURBANCE PLAN (U)

122

- (c) The preceding concept does not preclude USASTRATCOM detachments from being positioned in selected locations near troubled areas in advance of a task force commitment when directed by DA/CDCC.
- (8) Communications for Reporting Troop Movement Data.
  - (a) Communications for reporting troop movement data from task forces home bases prior to deployment will be by existing facilities.
  - (b) Communications for reporting troop movement data from the objective city and/or task force command post will be as outlined in paragraph 3a(2) (a), (b), (c), (f), and appendix 1, this annex.
- b. CGUSCONARC CINCARSTRIKE will:
  - (1) Include in task forces sufficient organic C-E elements with equipment to support the task force commander's command control, administrative, and logistical communications requirements.
  - (2) Provide audio-visual support to the task force commander as shown at paragraph 3b (2), appendix 4, this annex.
- c. CGUSAMC will:
  - (1) Pre-position and maintain the augmentation C-E equipment as shown at appendix 3, this annex.
  - (2) Move requested C-E equipment to departure airfields for airlift transportation and/or overland to the user as directed by DA/CDCC.
  - (3) Assure that personnel accompany, issue, and give advice concerning C-E equipment being shipped to the user.
  - (4) Rehabilitate and repackage augmentation C-E equipment after return to the depots.

UNCLASSIFIED

G-4

~~CONFIDENTIAL~~

123

ANNEX G (COMMUNICATIONS-ELECTRONICS) TO DEPARTMENT OF THE ARMY  
CIVIL DISTURBANCE PLAN (U)

(5) Provide audio-visual support as outlined in paragraph 3b(3), appendix 4, this annex.

d. Director, Defense Communication Agency (DCA). Makes available DCA resources to support civil disturbance operations as required.

e. CGUSASTRATCOM will:

- (1) Organize, train, and equip 25 civil disturbance communications detachments to support DA, other Federal agencies, and task force commanders.
- (2) Prepare plans for and provide communications support for 25 task force headquarters simultaneously as outlined in appendix 5, this annex.
- (3) As sole contracting authority for all leased communications circuits required for civil disturbance operations:
  - (a) Establish procedures for receiving, accounting, processing, and callup of all leased communications circuits which may be required in support of DA, other Federal agencies, CONUS armies, and task force commanders committed to civil disturbance operations.
  - (b) Provide for preinstallation of leased communications circuits and equipment as directed by DA/CDCC.
  - (c) Provide for installation of all leased communications circuits and equipment as required, and when validated in accordance with appendix 2, this annex.
- (4) Provide a USASTRATCOM detachment in the objective area that will:
  - (a) Integrate the task force commander's communications with the DA Command and Control System (DACCS).
  - (b) Install, operate and maintain those specific communications facilities outlined in appendix 5, this annex.

ANNEX G (COMMUNICATIONS-ELECTRONICS) TO DEPARTMENT OF THE ARMY  
CIVIL DISTURBANCE PLAN (U)

124

- (c) Establish and maintain coordination and liaison with the task force signal officer.
  - (d) Provide such other communications as may be required by DA, the PLOCSA, and Federal agencies or representatives in the objective area.
  - (e) Provide for the installation of all leased communications circuits and equipment when required, and when validated in accordance with the procedures outlined in appendix 2, this annex.
  - (f) Provide leased communications support to CGUSAINTC as required.
  - (g) Arrange for mobile telephone service as required by the task force commander.
- (5) Plan for the deployment of USASTRATCOM detachments to objective areas and/or preselected locations by military air transportation in accordance with paragraph 5, appendix 3, annex D, except in those cases where movement by other means will meet time-phase requirements.
- (6) Plan for and provide special communications support to the Washington, D. C. area by:
- (a) Designating one of the 25 USASTRATCOM detachments to support task force operations in the Washington area.
  - (b) Accomplishing the special communications tasks peculiar to the requirements of the Washington, D. C. area, as outlined in appendix 5 to this annex.
- f. Task Force Commanders will:
- (1) Provide intratask force tactical communications.
  - (2) Request necessary leased communications circuits in accordance with appendix 2, this annex.
  - (3) Take into the objective area the commercial equipment, as outlined in 3a(2)(b), (c), (d), and (e).



~~CONFIDENTIAL~~

UNCLASSIFIED

125

ANNEX G (COMMUNICATIONS-ELECTRONICS) TO DEPARTMENT OF THE ARMY  
CIVIL DISTURBANCE PLAN (U)

- (4) Provide the anticipated time and place of his arrival in the objective area to USASTRATCOM-CONUS (Area Code 301, telephone 763-2070, 763-2071, or 763-2072) in order to accomplish the timely provision of a civilian car with installed MTS. The task force commander is also responsible for providing a qualified MTS operator/driver for the MTS car.

g. CO, Army Photographic Agency, will, when directed by the DCDEPO, provide audio-visual support to the CofSA/CDCC and staff elements of DA in accordance with appendix 4, this annex.

h. Coordinating Instructions:

- (1) Basic Plan.
- (2) The task force signal officer, in coordination with the USASTRATCOM detachment commander, will be responsible for publishing and distributing a current telephone directory, and for maintaining other pertinent signal publications up to date.

4. (U) ADMINISTRATION AND LOGISTICS

Basic Plan.

5. (C) COMMAND AND SIGNAL

a. Command.

- (1) Basic Plan.
- (2) All USASTRATCOM personnel will be placed under command of the USASTRATCOM detachment commander.
- (3) The USASTRATCOM detachment will be under the operational control of the task force commander when in the objective area. The detachment commander will report to the task force commander immediately on arrival in the objective area.
- (4) The Army Photographic Agency photographic teams will report to the ACSC-E representative on the DALT Team who will be responsible for controlling the team's activities.

G-7

~~CONFIDENTIAL~~

UNCLASSIFIED

~~CONFIDENTIAL~~

UNCLASSIFIED

ANNEX G (COMMUNICATIONS-ELECTRONICS) TO DEPARTMENT OF THE ARMY  
CIVIL DISTURBANCE PLAN (U)

126

b. Signal. The following procedures will govern frequency/call sign authorizations:

- (1) Frequencies. Task force commanders are responsible for coordinating the overall frequency requirements within their respective forces, including the requirements of units assigned from the other Services. Task force requirements will be directed to the Army Area frequency coordinator responsible for the objective area. Unless otherwise directed by their respective task force commanders, Reserve component units will be authorized to use their training frequencies when operating within the Army Area to which assigned. For frequency purposes, MDW is considered a separate Army Area.
- (2) Call Signs. Task force commanders are responsible for coordinating the overall assignment/use of call signs within their respective forces. Unless otherwise directed by their task force commanders, all units will be authorized to use their normally assigned call signs.

- Appendixes:
- 1 - Standard City Wiring Package  
TAB A - List of Prewired Cities
  - 2 - Leased Communications Circuits Responsibilities and Requesting Procedures
  - 3 - Augmentation C-E Equipment  
TAB A - Items Pre-positioned and Composition of Packets  
TAB B - Procedures to Obtain C-E Equipment for Active Army and Called National Guard  
TAB C - Procedures to Obtain C-E Equipment State NG
  - 4 - Audio-visual  
TAB A - Audio-visual Support Centers  
TAB B - Recommended Team Package
  - 5 - Communications Support Requirements (USASTRATCOM)

UNCLASSIFIED

G-8

~~CONFIDENTIAL~~

127

APPENDIX 1 (STANDARD CITY WIRING PACKAGE) TO ANNEX G (COMMUNICATIONS-ELECTRONICS) TO DEPARTMENT OF THE ARMY CIVIL DISTURBANCE PLAN (U)

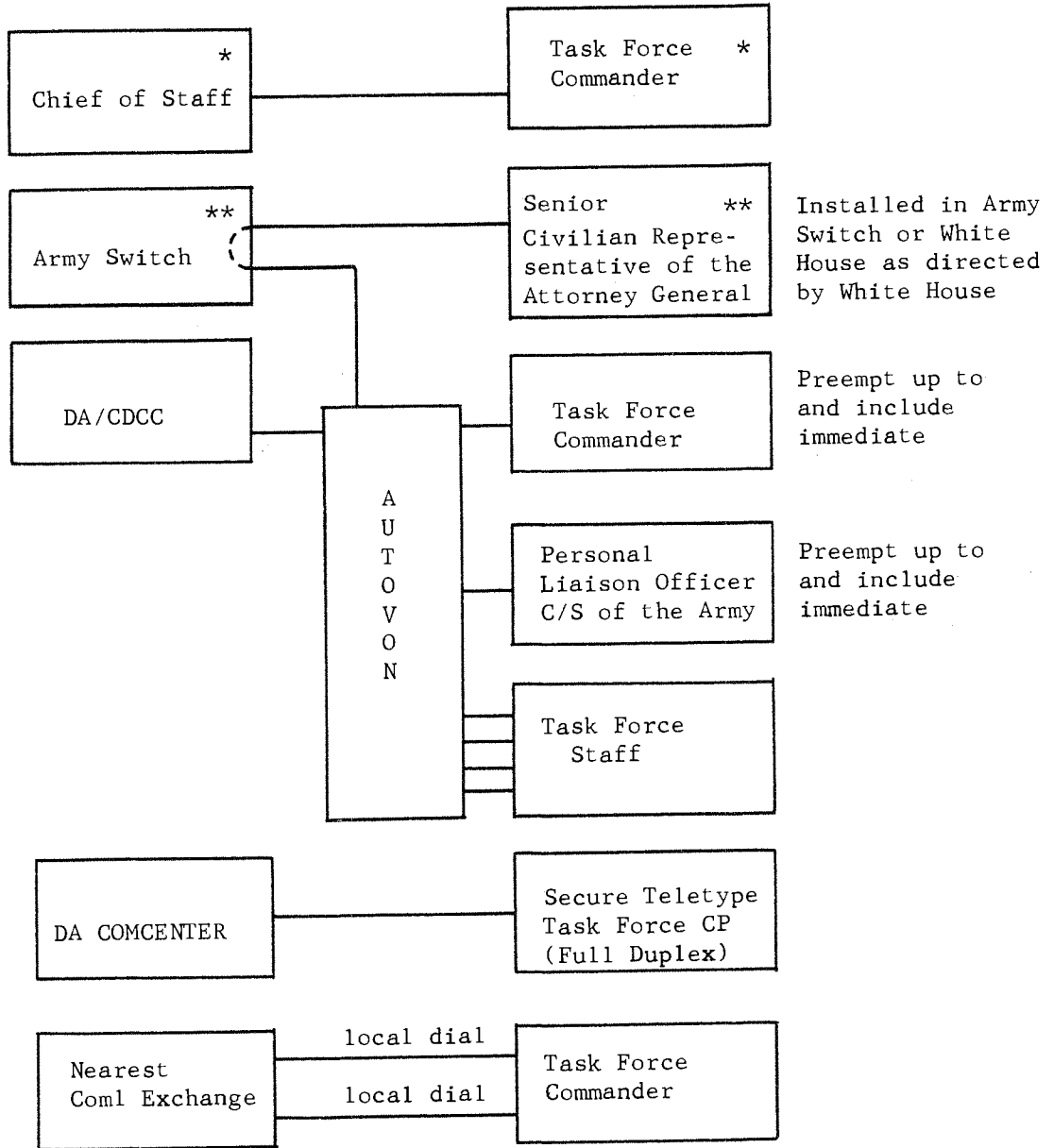

\* Pt to Pt  
\*\* Pt to Pt w/access to AUTOVON

TAB A- List of Prewired Cities

G-1-1



129

TAB A (LIST OF PREWIRED CITIES) TO APPENDIX I (STANDARD CITY WIRING PACKAGE) TO ANNEX G (COMMUNICATIONS - ELECTRONICS) TO DEPARTMENT OF THE ARMY CIVIL DISTURBANCE PLAN (U)

<u>CITIES</u>	<u>TASK FORCE COMMAND POSTS LOCATIONS</u>
Atlanta, GA	Municipal Auditorium, 30 Courtland St.
Baltimore, MD	5th Reg Armory, Bolton & Hoffman Sts.
Baton Rouge, LA	Army Reserve Tng Ctr, 1735 Foss St.
Birmingham, AL	City Auditorium, 1930 8th Ave, North
Boston, MA	White Stadium, Franklyn Park & Columbia Rd
Buffalo, NY	Police HQ, 74 Franklin St.
*Cambridge, MD	State Armory, 310 Gay St.
Chicago, IL	NG Armory, 234 E. Chicago Ave.
Cincinnati, OH	Police HQ, 310 Lincoln Park Drive
Cleveland, OH	City Central Underground Mall, 6th & St. Clair
Detroit, MI	Arty Armory, 1500 W. 8 Mi. Rd
E. St. Louis, IL	NG Armory, 2931 State St.
Hammond, IN	NG Armory, 2053 173d St.
Hartford, CT	State Armory, 360 Broad St.
Jacksonville, FL	NG Armory, 851 N. Market
Kansas City, MO	New State Office Bldg, 14th & Cherry Sts.
Los Angeles, CA	City Police Headquarters, 150 N. Los Angeles (primary)  LA Central Jail, 441 Dauchet St.(alternate)
Louisville, KY	Police HQ, 6th & Jefferson Sts.
Memphis, TN	NG Armory, 2525 Central Ave.
Miami, FL	Dade County NG Armory, 2728 N.W. 7th Ave.
Milwaukee, WI	NG Armory, 4108 N. Richards G-1-A-1

TAB A (LIST OF PREWIRED CITIES) TO APPENDIX 1 (STANDARD CITY WIRING PACKAGE) TO ANNEX G (COMMUNICATIONS - ELECTRONICS) TO DEPARTMENT OF THE ARMY CIVIL DISTURBANCE PLAN (U)

Nashville, TN	NG Armory, Cidgo Drive
Newark, NJ	Roseville Armory, 120 Roseville Ave.
New Orleans, LA	Naval Support Center, West Bank, Norman Meyer Blvd.
New York, NY	42 Inf Armory, 100 E. 34th St.
*Oakland, CA	Police Dept, 455 7th St.
Philadelphia, PA	City Hall, Market & Broad
Pittsburgh, PA	Police HQ, 3d & Grant
Richmond, VA	Police Dept, 501 N. 9th St.
St. Louis, MO	NG Armory, 3676 Market St.
*San Francisco, CA	Hall of Justice, 850 Bryant St.
Trenton, NJ	Lawrenceville/Trenton Armory, Eggerts Crossing Ave., Eggerts Rd, Lawrenceville
Wilmington, DE	NG Armory, 10th & DuPont
Youngstown, OH	Police HQ, 116th W. Boardman
Ft Lauderdale, FL	Police Dept, 1300 W. Broward Blvd.

\*Wired to Main Frame only.

131

APPENDIX 2 (LEASED COMMUNICATIONS CIRCUITS RESPONSIBILITIES AND REQUESTING PROCEDURES) TO ANNEX G (COMMUNICATIONS-ELECTRONICS) TO DEPARTMENT OF THE ARMY CIVIL DISTURBANCE PLAN (U)

1. PURPOSE

The purpose of this appendix is to prescribe the responsibilities and routing procedures for requesting leased communications circuits required for civil disturbance operations.

2. GENERAL

Circuits for the Standard City Wiring Package (appendix 1, this annex) will be requested by DA from the commercial telephone companies through USASTRATCOM. Additional leased communications circuits required for civil disturbance operations will be in accordance with the responsibilities and procedures outlined in paragraph 3 below.

3. LEASED COMMUNICATIONS CIRCUITS RESPONSIBILITIES AND REQUESTING PROCEDURES

a. CGUSASTRATCOM is the contracting authority for all leased communications circuits required for civil disturbance operations.

b. Prior to deployment of Federal military forces, requests for long distance leased communications circuits will be processed through DA/DCDPO-CE.

c. Subsequent to deployment of Federal military forces, requests for long distance leased communications circuits will be processed through DA/CDCC.

d. Task force requesting procedures in the objective area will be as follows:

(1) Local Circuits.

(a) The task force signal officer places requirements directly on the USASTRATCOM detachment commander in the objective area.

(b) The USASTRATCOM detachment commander requests the circuit directly from the local commercial telephone company representative (TELCOREP).

(2) Long Distance Circuits.

G-2-1

APPENDIX 2 (LEASED COMMUNICATIONS CIRCUITS RESPONSIBILITIES AND REQUESTING PROCEDURES) TO ANNEX G (COMMUNICATIONS-ELECTRONICS) TO DEPARTMENT OF THE ARMY CIVIL DISTURBANCE PLAN (U)

- (a) The Task Force Signal Officer places requirements on the USASTRATCOM detachment commander or, in his absence, the ACSC-E representative on the DA Liaison Team (DALT).
- (b) The USASTRATCOM detachment commander/ACSC-E representative requests approval from DA/CDCC.
- (c) When approved by DA/CDCC, the CGUSASTRATCOM orders the installation of circuits.
- (d) If a DA/CDCC disapproval is received, the task force signal officer will be notified immediately.



~~CONFIDENTIAL~~

UNCLASSIFIED

133

APPENDIX 3 (AUGMENTATION C-E EQUIPMENT) TO ANNEX G (COMMUNICATIONS-ELECTRONICS) TO DEPARTMENT OF THE ARMY CIVIL DISTURBANCE PLAN (U)

1. (U) AUTHORITY

a. The CofSA is the approving authority for requests for C-E equipment.

b. DA/CDCC will direct, issue, and execute movement instructions for augmentation equipment.

2. (U) GENERAL

To meet anticipated C-E support requirements by both Active Army, USAR, and National Guard forces and active and Reserve units of other Services committed in civil disturbance operations, there are battalion, brigade, and division C-E support packets shown at Tab A (Items Pre-positioned and Composition of Packets).

3. (C) PROCEDURES TO ACQUIRE, ISSUE, AND RETURN C-E EQUIPMENT

a. Upon determination by competent authority that a requirement for pre-positioned C-E equipment exists, requests to obtain release of the equipment may be made by the most expeditious means available. Request for release of this equipment will be identified as a ROAD JUNCTION request.

b. Active Army procedures. Tab B (Procedures to Obtain C-E Equipment for Active Army and for Called National Guard).

(1) Prior to deployment, the task force commander will make requests for pre-positioned C-E equipment through respective CONUS Army commander to USCONARC; USCONARC will make appropriate recommendations and forward requests to DA/CDCC. The task force commander will insure that the initial requests include the requirements of units assigned from the other Services.

(2) Any additional C-E equipment required, once the task force is deployed, will be requested by the task force commander direct to DA/CDCC.

c. National Guard Procedures. Tab C (Procedures to Obtain C-E equipment for State National Guard).

(1) The appropriate state adjutant general will request pre-positioned C-E equipment through

G-3-1

~~CONFIDENTIAL~~

UNCLASSIFIED

~~CONFIDENTIAL~~  
UNCLASSIFIED

APPENDIX 3 (AUGMENTATION C-E EQUIPMENT) TO ANNEX G (COMMUNICATIONS-ELECTRONICS) TO DEPARTMENT OF THE ARMY CIVIL DISTURBANCE PLAN (U)

134

National Guard Bureau, Washington, D. C. The National Guard Bureau will make appropriate recommendations and forward the request to DA/CDCC for final approval.

- (2) Called National Guard forces will request pre-positioned C-E equipment in accordance with the procedures established for Active Army forces outlined in paragraph 3b above.

d. Upon approval of requests, DA/CDCC will direct HQ, USAMC, to move the C-E equipment to departure airfields for further airlift transportation to the user and/or move the equipment overland to the user.

e. Units utilizing the C-E equipment will return the equipment to the issuing depot by the most expeditious means possible within 15 days after being relieved of their commitment to the civil disturbance operation.

4. (C) DEPOT/PRE-POSITION SITES

Equipment is pre-positioned at Lexington Army Depot, First Army Area, Sacramento Army Depot, Sixth Army Area, and Tobyhanna Depot, First Army Area.

5. (U) TRANSPORTATION

Transportation will be provided as determined by DCDPO in coordination with (in priority):

- (1) National Guard Bureau
- (2) Air Force Resources
- (3) Commercial Air

6. (U) POINTS OF CONTACT FOR OBTAINING C-E EQUIPMENT

- a. DA/DCDPO, Pentagon, OX 50441, x424.
- b. NGB, Pentagon, OX 72252.

G-3-2

UNCLASSIFIED

~~CONFIDENTIAL~~

APPENDIX 3 (AUGMENTATION C-E EQUIPMENT) TO ANNEX G (COMMUN-  
ICATIONS-ELECTRONICS) TO DEPARTMENT OF THE ARMY CIVIL  
DISTURBANCE PLAN (U)

c. HQ, USAMC, Building T-7, Washington, D. C.

- (1) Duty Hours: USAMC Operations Center AC 202, OX 5041/2/3, AUTOVON 555-3390.
- (2) Non-duty Hours: USAMC Staff Duty Officer AC 202, OX 74206, AUTOVON 555-3390.

Tabs: A - Items Pre-positioned and Composition of Packets  
B - Procedures to Obtain C-E Equipment - Active Army and Called National Guard  
C - Procedures to Obtain C-E Equipment National Guard in State Status

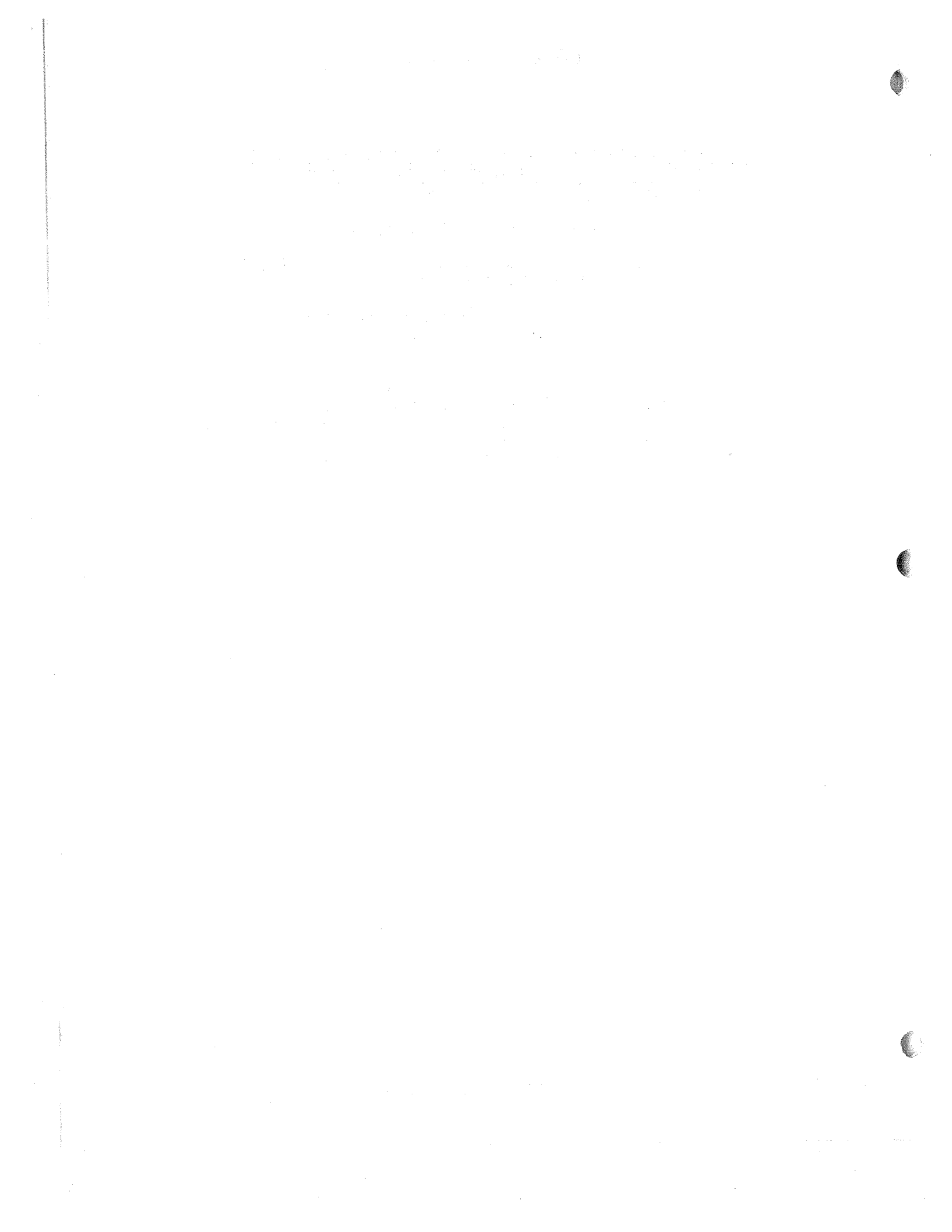

137

TAB A (ITEMS PRE-POSITIONED AND COMPOSITION OF PACKETS)  
TO APPENDIX 3 (AUGMENTATION C-E EQUIPMENT TO ANNEX G  
(COMMUNICATIONS-ELECTRONICS) TO DEPARTMENT OF THE ARMY  
CIVIL DISTURBANCE PLAN (U)

<u>PACKETS</u>	<u>ITEMS</u> <u>PER PACKET</u>	<u>NUMBER &amp; LOCATION OF</u> <u>PACKETS</u>	
Battalion	144 AN/PRC-10	8*	
	16 AN/VRC-10 w/mount	8**	
	2 AN/VRQ-3 w/mount	4***	
	4 AN/VRC-18 w/mount		
	6 Antenna Group RC-292	TOTAL 20	
	Brigade Base	2 AN/VRQ-3 w/mount and rectifier	2* 2**
		1 AN/GRC-46 w/100 AMP kit an rectifier	2***
	2 Antenna Group RC-292	TOTAL 6	
Division Base	4 AN/VRQ-3 w/mount and rectifier	1* 1**	
	1 AN/100 AMP kit and rectifier		
	3 Antenna Group RC-292	TOTAL 2	

NOTES:

1. DA/CDCC will determine which Army depot will provide equipment based primarily on relative distance of user from nearest depot.

2. AN/VRC-10 and AN/VRC-18 radios are to be mounted in 1/4 ton vehicles; AN/VRQ-3 radios are to be mounted in 1/2 ton vehicles or connected to an external power source; AN/GRC-46 radios are to be mounted in 3/4 ton vehicles or connected to an external power source.

- \*Lexington Army Depot
- \*\*Sacramento Army Depot
- \*\*\*Tobyhanna Army Depot

G-3-A-1



TAB B (PROCEDURES TO OBTAIN C-E EQUIPMENT FOR ACTIVE ARMY AND CALLED NATIONAL GUARD) TO APPENDIX 3 (AUGMENTATION C-E EQUIPMENT) TO ANNEX G (COMMUNICATIONS-ELECTRONICS) TO DEPARTMENT OF THE ARMY CIVIL DISTURBANCE PLAN (U)

PROCEDURES TO OBTAIN C-E EQUIPMENT  
ACTIVE ARMY AND CALLED NATIONAL GUARD

1. PRIOR TO DEPLOYMENT:

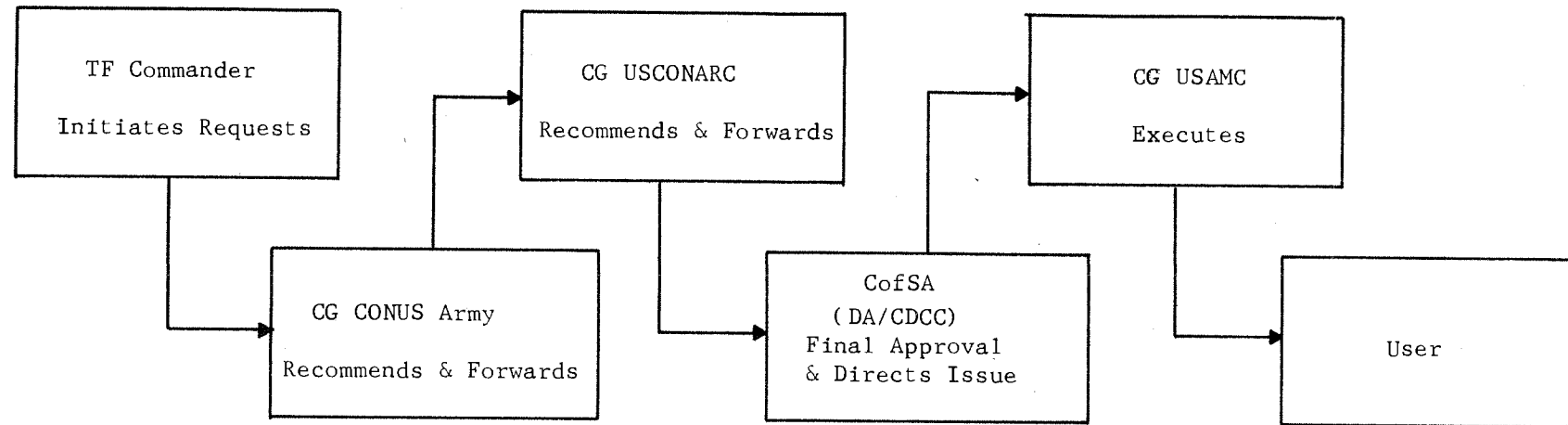

2. DEPLOYED IN OBJECTIVE AREA:

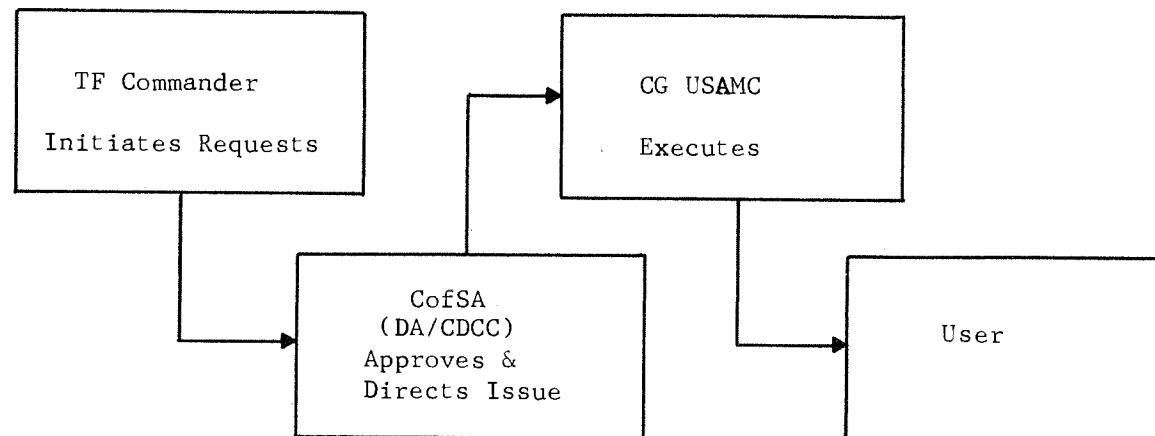





141

TAB C (PROCEDURES TO OBTAIN C-E EQUIPMENT STATE NATIONAL GUARD)  
TO APPENDIX 3 (AUGMENTATION C-E EQUIPMENT) TO ANNEX G (COMMUNICATIONS-  
ELECTRONICS) TO DEPARTMENT OF THE ARMY CIVIL DISTURBANCE PLAN (U)

PROCEDURES TO OBTAIN C-E EQUIPMENT  
STATE NATIONAL GUARD

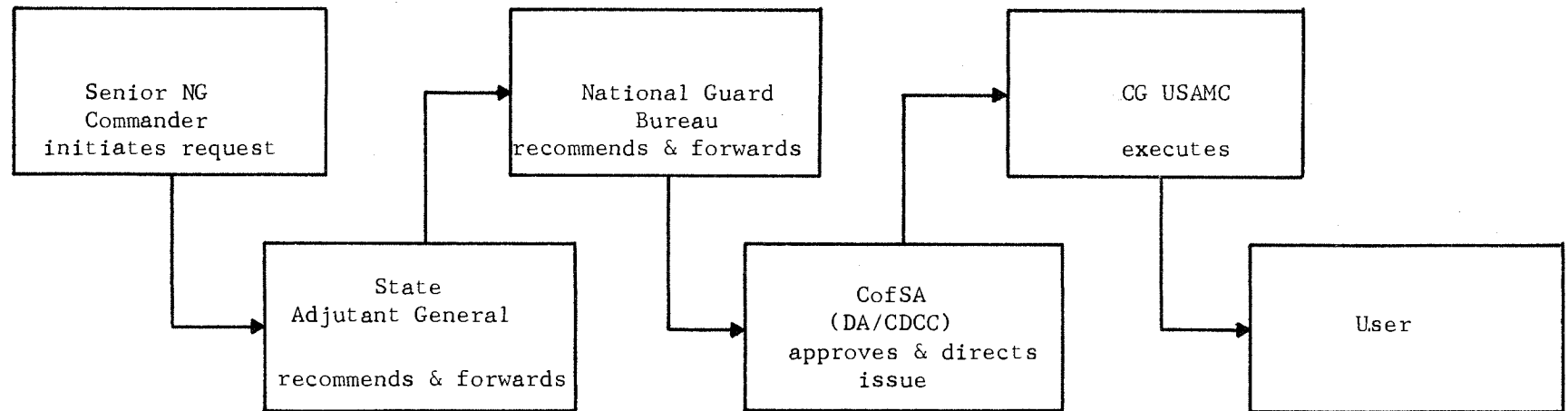



143

APPENDIX 4 (AUDIO-VISUAL) TO ANNEX G (COMMUNICATIONS-ELECTRONICS) TO DEPARTMENT OF THE ARMY CIVIL DISTURBANCE PLAN (U)

References:

- a. AR 108-5.
- b. AR 108-30.
- c. AR 108-40.

1. (U) SITUATION

Basic Plan.

2. (U) MISSION

To provide the Department of the Army and task force commanders responsive audio-visual support that contributes to the accomplishment of the civil disturbance mission and objectives. Audio-visual support includes television, motion pictures, still photography, pictorial reproduction, display, and distribution of audio-visual materials.

3. (U) EXECUTION

a. Concept of Audio-Visual Support:

(1) General Support:

(a) Audio-visual support will be provided to the Civil Disturbance Command Center (CDCC) and staff elements of the Department of the Army (DA). All requests from these agencies for audio-visual support, locally and elsewhere, within CONUS will be controlled and coordinated by the CDCC C-E Officer.

(b) General Support Photo Teams (GSPT) will be controlled and deployed by the DA/CDCC as required to provide rapid response pictorial coverage. When deployed these teams will report to the ACSC-E representative on the DALT. This representative will be responsible for directing and coordinating the teams' activities while in the area of operation.

(2) Task Force Support:

G-4-1

APPENDIX 4 ( AUDIO-VISUAL ) TO ANNEX G ( COMMUNICATIONS-  
ELECTRONICS ) TO DEPARTMENT OF THE ARMY CIVIL DISTURBANCE  
PLAN ( U )

144

- (a) Audio-visual support will be provided to the task force commanders by Task Force Photo Teams to accomplish still and motion picture photography.
- (b) Task Force Photo Teams when attached, are part of the task force commander's staff package and will be controlled and deployed on his order. An officer on the task force staff will coordinate and supervise audio-visual requirements.
- (c) The Audio-Visual Support Center closest to or within the area of operation will provide projection and associated equipment to the task force commanders (Tab A - Audio-Visual Support Center).

b. Responsibilities:

(1) ACSC-E

Provides policy, technical and operational guidance to the Civil Disturbance Directorate, when requested, on audio-visual matters. Assigns special project numbers to projects for identification of civil disturbance coverage.

(2) USCONARC

- (a) Arranges for and equips 25 Task Force Photo Teams consisting of one motion picture cameraman and two still photographers to be attached to and deployed with the task force to support the task force commander's requirements (Tab B - Recommended Team Package).
- (b) Arranges for responsive military or commercial contract still photographic laboratory processing services to support the task force commanders in their operational locations.
- (c) Arranges for loan of projection and associated equipment to the task force commander from the Audio-Visual Support Center closest to operational area (Tab A - Audio-Visual Support Center).

145

APPENDIX 4 (AUDIO-VISUAL) TO ANNEX G (COMMUNICATIONS-  
ELECTRONICS) TO DEPARTMENT OF THE ARMY CIVIL DISTURBANCE  
PLAN (U)

- (3) United States Army Materiel Command (USAMC)
- (a) Arranges through the Army Pictorial Center for military or commercial contract motion picture processing, printing, and distribution of civil disturbance special project coverage taken by the task force photo teams.
  - (b) Arranges for television personnel and equipment augmentation to CO, USAPA, as required.
- (4) US Army Photographic Agency (USAPA)
- Provide the CDCC and DA Staff through the DCDPO C-E Officer, television, motion picture, and still photography support to include:
- (a) Television for command and control, commercial program monitoring and video tape recording and playback in support of the CDCC.
  - (b) Still photographic laboratory processing and record center support.
  - (c) Personnel augmentation; projectionists and illustrators.
  - (d) Five general support photo teams (Tab B - Recommended Team Package).
  - (e) Motion picture processing at local military facilities or by commercial contract of USAPA exposed footage only.
  - (f) Motion picture editing.
- (5) Task Force Photo Teams
- (a) The teams will provide support to the task force commanders as required.
  - (b) Provide photographic support for the Information Officer's Programs and Activities.

G-4-3.

APPENDIX 4 (AUDIO-VISUAL) TO ANNEX G (COMMUNICATIONS-  
ELECTRONICS) TO DEPARTMENT OF THE ARMY CIVIL DISTURBANCE  
PLAN (U)

146

- (c) Provide for two 8x10 captioned prints of selected still photographs to be sent by the fastest practical means to the CDCC through the CO, USAPA, Department of the Army, Washington, DC 20310. The numbered and captioned negatives will be forwarded to CO, USAPA after task force requirements are accomplished.
- (d) Motion picture coverage with captions will be sent by fastest practical means to the Army Pictorial Center, 35-11 35th Avenue, Long Island City, New York 11106 for priority processing.
- (e) Self-processing photographs (Polaroid) may be used when the mission requires. Permanent record photographs (AR 108-5) should be copied and forwarded to CO, USAPA as appropriate.

c. Special Coordinating Instructions:

Standing Photographic Coverage Guide for Civil Disturbance Operations. This provides the commander with guidance as to the types of coverage that can be accomplished by the photo teams.

- (1) Confrontation of military personnel or unit dispersing mobs or crowds.
- (2) Looter activity.
- (3) Rioter attitudes and reactions.
- (4) Street, building, bivouac, and storage surveys.
- (5) Agitator activities.
- (6) Cooperation of military and civil personnel, activities, and organizations.
- (7) Copies of situation maps, documents, and evidence.

147

APPENDIX 4 (AUDIO-VISUAL) TO ANNEX G (COMMUNICATIONS-  
ELECTRONICS) TO DEPARTMENT OF THE ARMY CIVIL DISTURBANCE  
PLAN (U)

- (8) Conduct of military personnel.
- (9) Identification of property.
- (10) Document sensitive or critical areas such as utilities (water power), communication sites, bridges, docks, airfields, warehouses, hospitals, fire, and police stations, and transportation facilities.
- (11) Record historical speeches or events of national interest or importance.
- (12) Record new equipment, organizations, techniques, and methods of operation.
- (13) Document participating activities of civic groups such as Red Cross, Salvation Army, churches, and relief organizations.
- (14) Human interest subjects.
- (15) Photographs for information programs and activities.

4. (U) ADMINISTRATION AND LOGISTICS

a. Administration: Tab B - Recommended Team Package.

b. Logistics: Provide transportation for each photo team in the operational area.

5. (U) COMMAND AND SIGNAL

a. Command: Basic Plan.

b. Signal: Insure communications are maintained between the controlling headquarters and the photo teams while operating in the objective area.

Tabs: A - Audio-Visual Support Centers

B - Recommended Team Package

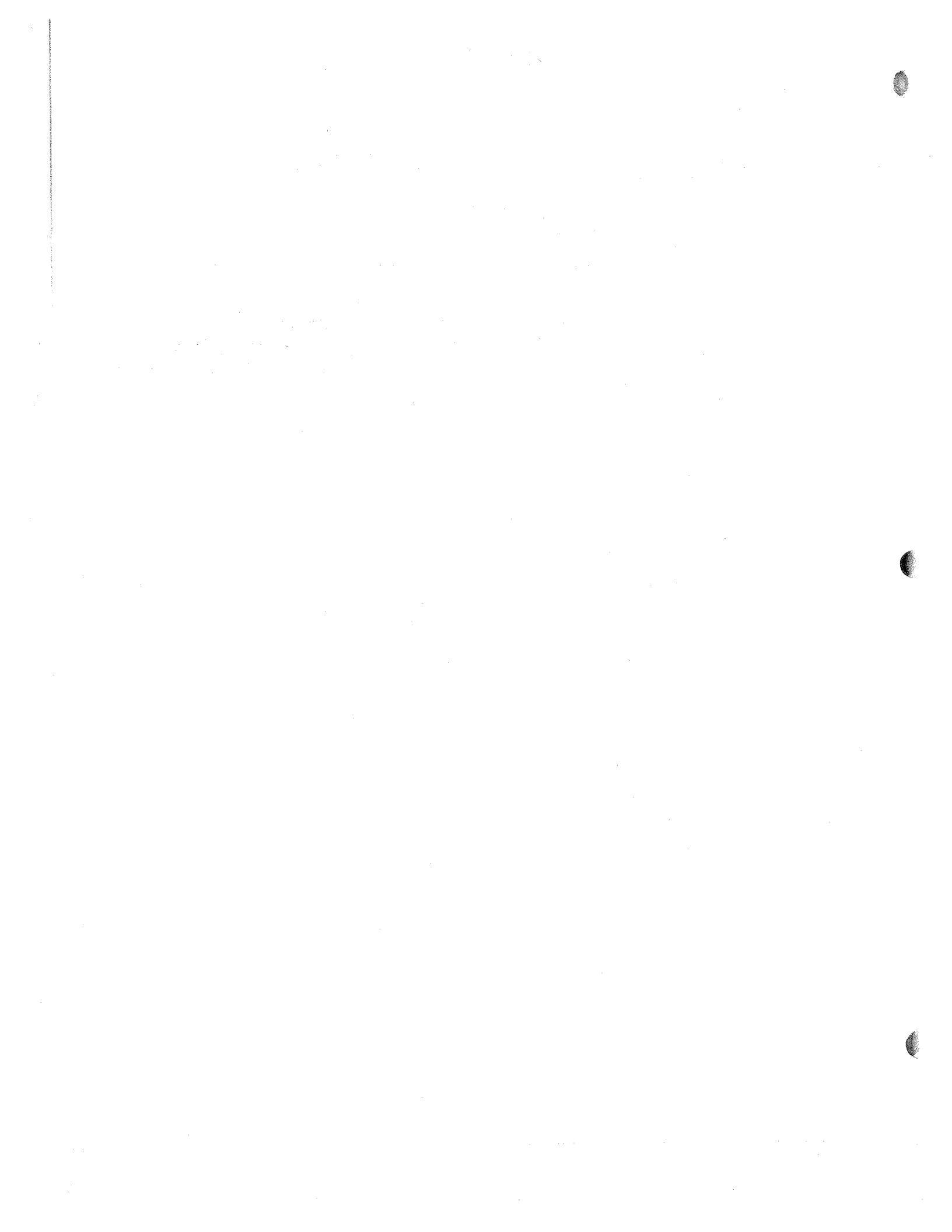



149

TAB A (AUDIO-VISUAL SUPPORT CENTERS) TO APPENDIX 4 (AUDIO-VISUAL)  
TO ANNEX G (COMMUNICATIONS - ELECTRONICS) TO DEPARTMENT OF THE  
ARMY CIVIL DISTURBANCE PLAN (U)

FIRST US ARMY

CENTER & LOCATION

CENTER & LOCATION

First US Army  
Fort George G. Meade, MD 20755

Fort Holabird  
Baltimore, MD 21219

Fort Hamilton/Wadsworth  
Fort Hamilton, NY 11252

Fort Monroe, VA 23351

Fort Devens, MA 01433

US Army Support Center, Niagara Falls  
P.O. Box 70, LaSalle Station  
Niagara Falls, NY 14303

Fort Knox, KY 40121

US Military Academy  
West Point, NY 10996

Fort Lee, VA 22060

Carlisle Barracks, PA 17023

Fort Belvoir, VA 22060

Frankford Arsenal  
Philadelphia, PA 19137

Fort Dix, NJ 08640

Picatinny Arsenal  
Dover, NJ 07801

Camp Drum  
Watertown, NY 13603

US Army Cold Region R&E Labs  
Hanover, NH 03755

Fort Eustis, VA 23604

Tobyhanna Army Depot  
Tobyhanna, PA 18466

Boston Army Base  
Boston, MA 02110

Cleveland Procurement District  
Cleveland, OH 44114

Fort Monmouth, NJ 07703

Judge Advocate General's School  
Charlottesville, VA 22901

Letterkenny Army Depot  
Chambersburg, PA 17201

Watertown Arsenal  
Watertown, MA 02172

Lexington-Blue Grass  
Lexington, KY 40507

US Army Reserve Center (R)  
Indiantown Gap Mil. Reservation  
Annville, PA 17003

G-4-A-1

TAB A (AUDIO-VISUAL SUPPORT CENTERS) TO APPENDIX 4 (AUDIO-VISUAL)  
TO ANNEX G (COMMUNICATIONS - ELECTRONICS) TO DEPARTMENT OF THE  
ARMY CIVIL DISTURBANCE PLAN (U)

FIRST US ARMY  
(cont)

CENTER & LOCATION

CENTER & LOCATION

Natick Labs  
Natick, MA 01760

83D USARCOM (R), Bldg-110, Ft Hayes  
Columbus, OH 43215

New Cumberland Army Depot  
P.O. Box 2947  
Harrisburg, PA 17105

US Army Support Det., Oakdale (R)  
Oakdale, PA 15071

Springfield Armory  
Springfield, MA 01101

ARTC, Hartford, CT 06110 (R)

Valley Forge Army Hospital  
Phoenixville, PA 19460

Maine Sector XIII, US Army Corps (R)  
Fort Williams  
So. Portland, MA 04106

Watervliet Arsenal  
Watervliet, NY 12189

N. W. ARTC, Burlington, VT 05401 (R)

Cincinnati Procurement District  
Cincinnati, OH 45202

ARTC, Providence, RI 02907 (R)

THIRD US ARMY

Third US Army  
Fort McPherson, GA 30330

Audio Visual Support Center  
P. O. Box 311  
Raleigh, NC 27602

Fort Benning, GA 31905

Federal Court House  
Columbia, SC 29201

Fort Bragg, NC 28307

Audio Visual Support Center  
607 N. 31st St.  
Birmingham, AL 35222

Fort Rucker, AL 36360

Charleston Army Depot  
N. Charleston, SC 29405

Redstone Arsenal, AL 35808

Memphis Army Depot  
Memphis, TN 38115

151

TAB A (AUDIO-VISUAL SUPPORT CENTERS) TO APPENDIX 4 (AUDIO-VISUAL)  
TO ANNEX G (COMMUNICATIONS - ELECTRONICS) TO DEPARTMENT OF THE  
ARMY CIVIL DISTURBANCE PLAN (U)

THIRD US ARMY  
(cont)

CENTER & LOCATION

CENTER & LOCATION

Fort Gordon, GA 30905

Sunny Point Military Ocean Terminal  
Southport, NC 28461

Fort Stewart, GA 31313

Fort Campbell, KY 42223

Fort Jackson, SC 29207

Fort McClellan, AL 36201

Audio-Visual Support Center  
3005 Talleyrand Ave.  
Jacksonville, FL 32205

Audio-Visual Support Center  
Bullard St. at Columbia Ave.  
Jackson, MI 39209

FOURTH US ARMY

Fourth US Army  
Fort Sam Houston, TX 78234

Fort Wingate Army Depot  
Gallup, NM 87301

Fort Sill, OK 73503

Fort Bliss, TX 79906

Fort Hood, TX 76544

Fort Polk, LA 71450

Fort Wolters  
Mineral Wells, TX 76067

Pine Bluff Arsenal  
Pine Bluff, AR 71701

Red River Army Depot  
Texarkana, TX 75502

Audio-Visual Support Center  
Sandia Base, NM 87115

FIFTH US ARMY

Fifth US Army  
Camp McCoy  
Sparta, WI 54656

US Army Aviation Material Command  
12th & Spruce Streets  
St. Louis, MO 63102

Fort Leonard Wood, MO 65473

Command & General Staff College  
Fort Leavenworth, KS 66027

Fort Carson, CO 80913

Fort Riley, KS 66442

Rock Island Arsenal  
Rock Island, IL 61201

Savanna Army Depot  
Savanna, IL 61074

G-4-A-3

TAB A (AUDIO-VISUAL SUPPORT CENTERS) TO APPENDIX 4 (AUDIO-VISUAL)  
TO ANNEX G (COMMUNICATIONS - ELECTRONICS) TO DEPARTMENT OF THE  
ARMY CIVIL DISTURBANCE PLAN (U)

152

FIFTH US ARMY  
(cont)

<u>CENTER &amp; LOCATION</u>	<u>CENTER &amp; LOCATION</u>
Fort Benjamin Harrison, IN 46216	USA Field Safety Office Charlestown, IN
Support Center, Chicago 1660 E. Hyde Park Blvd. Chicago, IL 60615	88th USARCOM (R) 108 Buzza Bldg., 1006 W. Lake St. Minneapolis, MN 55403
Pueblo Army Depot Pueblo, CO 81001	US Army Reserve Center (R) 21st & Woolworth Ave. Omaha, NB 68108
US Army Tank Automotive Command Warren, MI 48039	Cornhusker Army Ammunition Plant Grand Island, NB 68801
Granite City Army Depot Granite City, IL 62040	Jefferson Proving Ground Madison, IN 47251

SIXTH US ARMY

Sixth US Army Presidio of San Francisco, CA 94129	Ogden Defense Depot Ogden UT 84401
Fort Lewis, WA 98433	Fort MacArthur, CA 90731
Fort Ord, CA 93941	Fort Douglas, UT 84113
Fort Huachuca, AZ 85613	Sacramento Army Depot Sacramento, CA 95913
Fort Irwin, CA 92310	Sierra Army Depot Herlong, CA 96113
Yuma Proving Ground Yuma, AZ 85364	Umatilla Army Depot Hermisten, OR 97838
Oakland Army Base Oakland, CA 94626	OCINFO, LA Branch 6087 Sunset Blvd. Hollywood, CA 90028

G-4-A-4

153

TAB A (AUDIO-VISUAL SUPPORT CENTERS) TO APPENDIX 4 (AUDIO-VISUAL)  
TO ANNEX G (COMMUNICATIONS - ELECTRONICS) TO DEPARTMENT OF THE  
ARMY CIVIL DISTURBANCE PLAN (U)

SIXTH US ARMY

CENTER & LOCATION

CENTER & LOCATION

Defense Language Institute (WC)  
Presidio of Monterey, CA 93940

Tooele Army Depot  
Tooele, UT 84074

Dugway Proving Ground  
Dugway, UT 84022

Navajo Army Depot  
Flagstaff, AZ 86000

MILITARY DISTRICT OF WASHINGTON (MDW)

MDW Audio-Visual Support Center  
Bldg. 201 - North Post  
Fort Myer, VA 22211

US Army Photographic Agency  
Room 5A-1072, Pentagon  
Washington, DC 20315

G-4-A-5



155

TAB B (RECOMMENDED TEAM PACKAGE) TO APPENDIX 4 (AUDIO-VISUAL) TO  
ANNEX G (COMMUNICATIONS-ELECTRONICS) TO THE ARMY CIVIL DISTURBANCE  
PLAN (U)

1. GENERAL SUPPORT PHOTO TEAM (GSPT)

a. Personnel:

2 EM MOS 84C20 MOPIC  
1 EM MOS 84B40 Still Photographer  
1 Officer MOS 8511 Team Leader or equivalent NCO

b. Equipment:

16mm MOPIC Camera (Sound)	2 per team
Sound Recording System	1 per team
16mm MOPIC Camera (Silent)	2 per team
Portable Lighting Set	1 per team
Reflex Camera, Still (120 film)	2 per team
35mm still camera	2 per team
Electronic Flash	2 per team
Exposure meter	4 per team
Tripods	2 per team
Polaroid Camera	2 per team
Typewriter	1 per team

c. Supplies: A basic load of expendable supplies for 10 days of operation is required.

2. TASK FORCE PHOTO TEAM

a. Personnel:

1 EM MOS 84C20 MOPIC Photographer  
2 EM MOS 84B20 Still Photographer

b. Equipment:

Portable Lighting Set	1 per team
Exposure meter	1 per photographer
Press Type Camera	1 per still photographer
35mm Still Camera	1 per still photographer
Electronics Flash	1 per still photographer
Tripod	1 per photographer
16mm MOPIC Camera	1 per MOPIC photographer
Polaroid Camera	3 per team
Typewriter, Portable	1 per team
8" x 10" viewer	1 per team
Duplication: Spirit Manual	1 per team

G-4-B-1

TAB B (RECOMMENDED TEAM PACKAGE) TO APPENDIX 4 (AUDIO-VISUAL) TO  
ANNEX G (COMMUNICATIONS-ELECTRONICS) TO THE ARMY CIVIL DISTURBANCE  
PLAN (U)

156

KS-77 (MP-3, 1 Polaroid Camera Set,  
Still) 1 per team

c. Supplies: A basic load of expendable supplies for 10 days operation is required.

G-4-B-2



~~CONFIDENTIAL~~

UNCLASSIFIED

157

APPENDIX 5 (COMMUNICATIONS SUPPORT REQUIREMENTS (USASTRATCOM))  
TO ANNEX G (COMMUNICATIONS - ELECTRONICS) TO DEPARTMENT OF THE  
ARMY CIVIL DISTURBANCE PLAN (U)

1. (U) MISSION

USASTRATCOM will prepare plans for and provide the communications support outlined in annex G and this appendix.

2. (C) EXECUTION

a. Arrange for the provision of a civilian car equipped with MTS to the task force commander upon his arrival in the objective city. (Does not include Washington, D. C.)

b. Arrange for the leasing and installation of the teletypewriter equipment required for a secure full duplex teletypewriter circuit from DA/CDCC to each task force main CP. (Less Task Force Washington)

c. Provide the necessary security equipment (TSEC KW-7) for the teletypewriter circuit described in paragraph b, above.

d. Provide a standby reserve of 12 HF/SSB (KW-2) voice radios and 24 operators to meet emergency or unforeseen requirements.

e. Provide two (2) Dataphones 603 to each of 24 designated task force commanders for establishing communication circuits from objective city to CDCC before standard communication packet becomes operational.

f. Provide a USASTRATCOM Detachment to support DA, other Federal agencies, and task force operations in the Washington, D. C. area that will:

- (1) Lease and operate a CENTREX Dial Telephone System for use by CDCC, other Federal agencies, and Task Force Washington as directed by DA/CDCC.
- (2) Lease and operate a three-position switchboard (608) associated with the CENTREX Telephone System referred to in paragraph f(1) above.

G-5-1

~~CONFIDENTIAL~~ UNCLASSIFIED

~~UNCLASSIFIED~~

~~CONFIDENTIAL~~

APPENDIX 5 (COMMUNICATIONS SUPPORT REQUIREMENTS (USASTRATCOM))  
TO ANNEX G (COMMUNICATIONS-ELECTRONICS) TO DEPARTMENT OF THE  
ARMY CIVIL DISTURBANCE PLAN (U)

158

- (3) Lease and operate a switchboard (60/20) in support of the DA/CDCC.
  - (4) Lease and operate a special FM radio switching, paging, and RWI System in support of Task Force Washington and key DA staff personnel.
  - (5) Provide and install leased FM radio equipment in leased or government vehicles as directed by DA/CDCC.
  - (6) Provide driver/operators for the installed FM radio equipment referred to in paragraph f(4) above.
  - (7) Provide personnel and facilities for 24 secure (KW-7) teletypewriter circuits from DA to task force commanders.
  - (8) Provide or arrange for backup power for all USASTRATCOM furnished communications equipment.
  - (9) Provide and control the issue of 24 portable tape recorders for the PLOCSA as directed by DA/CDCC.
  - (10) Prepare, publish, distribute, and maintain current, all task force basic telephone numbers.
  - (11) Provide termination facilities for Dataphone 603 circuits at DA/CDCC.
  - (12) Provide the equipment and personnel to install, operate and maintain a total of 24 HF/SSB (KWM-2) voice radio circuits from DA/CDCC to task force main CP.
- g. Provide a USASTRATCOM detachment to support task force operations in objective areas other than the Washington, D. C. area that will:
- (1) Order up local leased circuits as requested by the task force commanders.
  - (2) Forward requests for long-distance leased circuits placed by the task force commanders to DA/CDCC for approval; upon approval, CGUSASTRATCOM orders approved circuits from the commercial telephone company.

~~UNCLASSIFIED~~

G-5-2

~~CONFIDENTIAL~~

~~CONFIDENTIAL~~

UNCLASSIFIED

159

APPENDIX 5 (COMMUNICATIONS SUPPORT REQUIREMENTS (USASTRATCOM))  
TO ANNEX G (COMMUNICATIONS-ELECTRONICS) TO DEPARTMENT OF THE  
ARMY CIVIL DISTURBANCE PLAN (U)

- (3) Provide personnel and facilities for secure (KW-7) teletypewriter circuits from DA to task force commanders.
- (4) Operate a USASTRATCOM leased switchboard having the following minimum capabilities for the task force main CP:
  - (a) 2 - wire.
  - (b) 100 telephone terminations.
  - (c) Terminate six dial trunks from local commercial exchange.
  - (d) 10-ring down trunks - either manual or automatic.
- (5) Provide and/or arrange for backup power for USASTRATCOM furnished communications equipment in the objective area.
- (6) Provide the equipment and personnel to install, operate and maintain HF/SSB (KWM-2) voice radio circuit from DA/CDCC to task force main CP.

G-5-3

~~CONFIDENTIAL~~

UNCLASSIFIED

CONFIDENTIAL

CONFIDENTIAL

161

ANNEX H (COMMAND RELATIONSHIPS) TO DEPARTMENT OF THE ARMY CIVIL  
DISTURBANCE PLAN (U)

References:

- a. DOD Directive 3025.12, 8 June 1968.
- b. JCS Pub 1.

The Directorate for Civil Disturbance Planning and Operations (DCDPO), with a joint Service staff has been established under the Chief of Staff, US Army (CofSA) by the DOD Executive Agent, to plan, coordinate, and direct civil disturbance operations. Appendixes 1 through 3 depict command relationships for planning and operations in civil disturbance matters.

- Appendixes:
- 1 - Command Relationships for Planning
  - 2 - Command Relationships for CONUS Deployment and Redeployment
  - 3 - Command Relationships for Employment



APPENDIX 1 (COMMAND RELATIONSHIPS FOR PLANNING) TO ANNEX H  
(COMMAND RELATIONSHIPS) TO DA CIVIL DISTURBANCE PLAN (U)

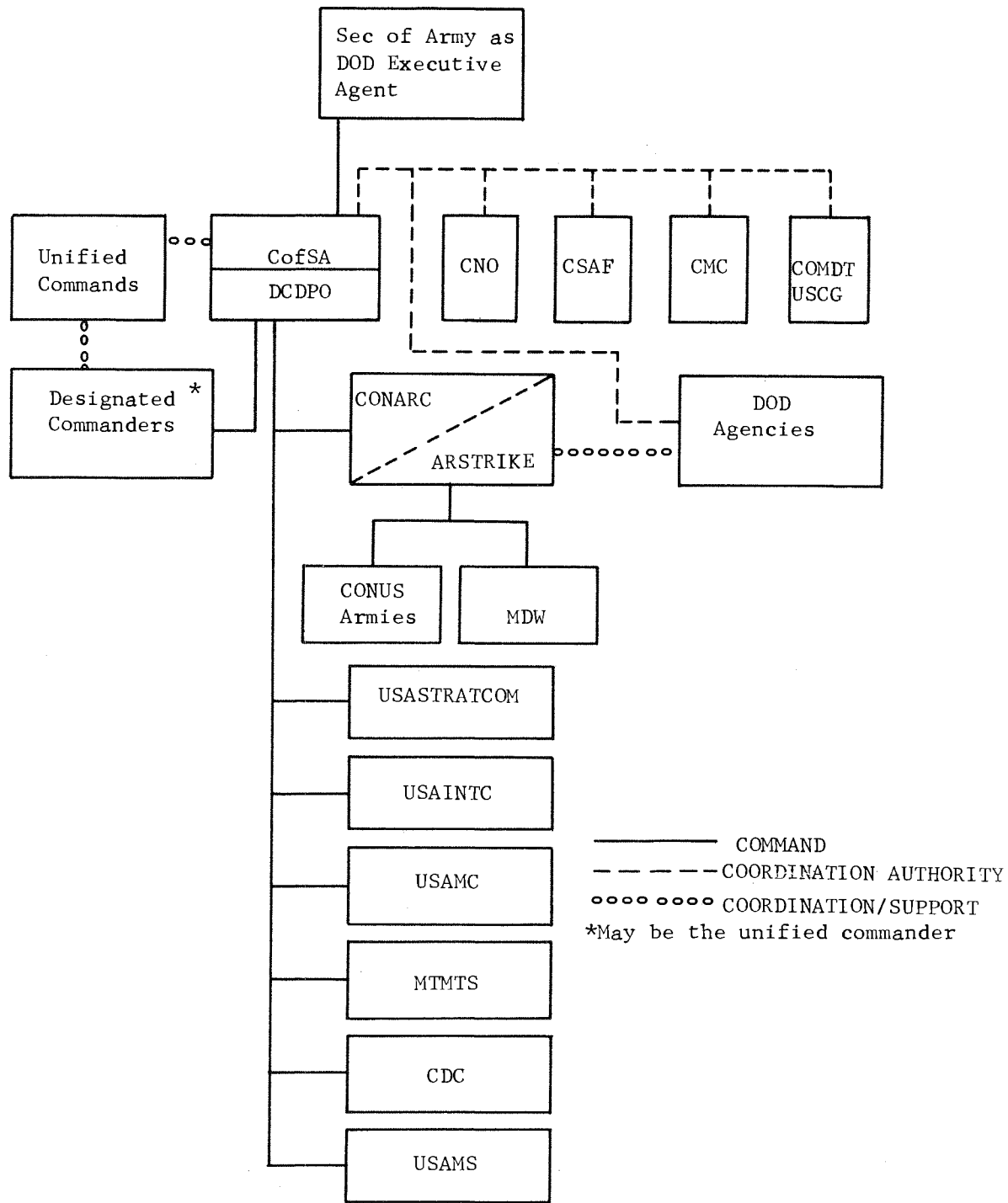





APPENDIX 2 (COMMAND RELATIONSHIPS FOR CONUS DEPLOYMENT AND REDEPLOYMENT)  
TO ANNEX H (COMMAND RELATIONSHIPS) TO DEPARTMENT OF THE ARMY CIVIL DISTUR-  
BANCE PLAN (U)

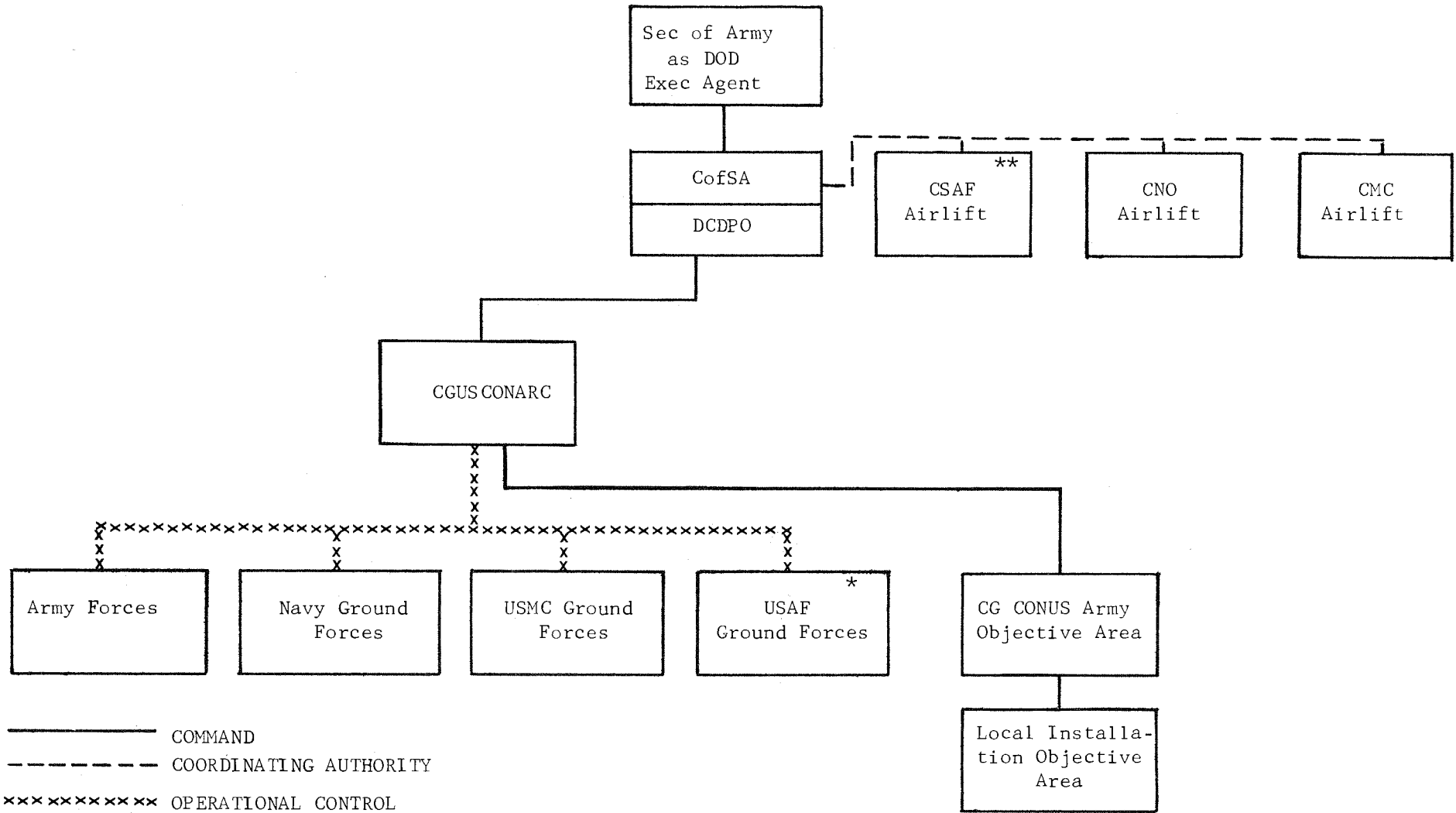

o o o o o o o o o o COORDINATION/SUPPORT

\*USAF Ground Forces are deployed and redeployed as directed by CofSA.

\*\*The CSAF Exercises for the DOD Executive Agent, through designated military commanders, coordinating authority over and direction of DOD provided military and commercial obligated airlift resources used to fulfill civil disturbance airlift requirements.



APPENDIX 3 (COMMAND RELATIONSHIPS FOR EMPLOYMENT) TO ANNEX H  
(COMMAND RELATIONSHIPS) TO DA CIVIL DISTURBANCE PLAN (U)

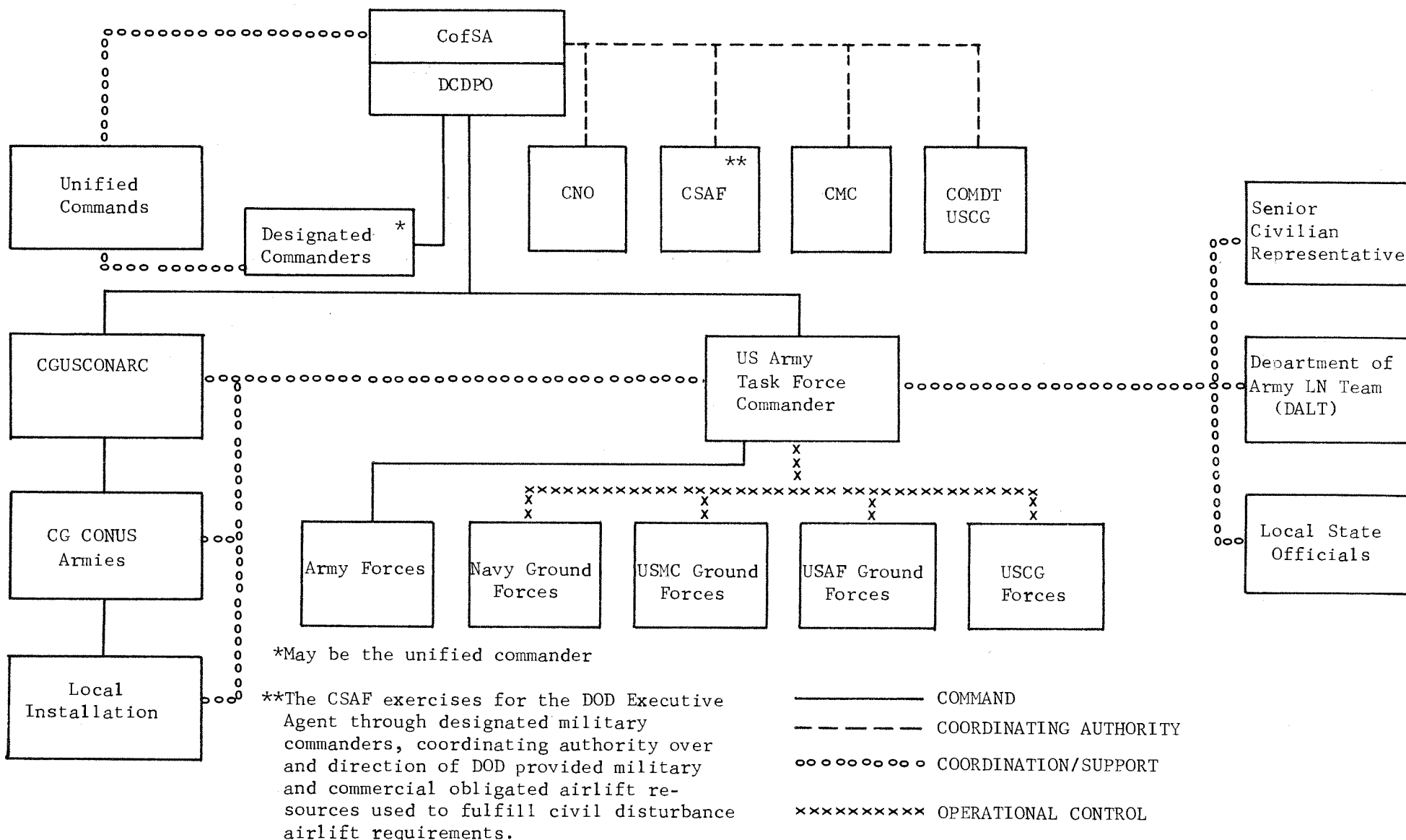

NOTE: CINCSTRIKE provides military resources to commanders of unified commands and Military Departments as directed.



~~CONFIDENTIAL~~

UNCLASSIFIED

169

ANNEX I (PLANNING) TO DEPARTMENT OF THE ARMY CIVIL DISTURBANCE  
PLAN (U)

1. (U) GENERAL

The DA Civil Disturbance Plan provides guidance to all DOD components in all matters pertaining to the planning for and the deployment and employment of military resources in the event of civil disturbances in the 50 states, District of Columbia, Commonwealth of Puerto Rico, US possessions and territories.

2. (C) PLANNING REQUIREMENTS

a. Priority Objective Areas:

(1) CONUS. Potential objective areas are grouped within CONUS Army Areas to facilitate planning for the deployment of civil disturbance forces and are listed as High, Intermediate, and Low Priority (appendix 1, this annex). For planning purposes, 25 High Priority objective areas have been identified, and it is assumed that civil disturbances will occur simultaneously in these objective areas. Further, it is anticipated that the total strength of forces involved will reach five brigades, inclusive of all participating Services and Reserve Components plus supporting elements, in each objective area with the exception of the Washington, D.C. area where forces totaling 30,000 troops may be employed.

(2) Areas outside of CONUS. Designation of objective areas and their priorities outside of CONUS are, for both planning and operations, a responsibility of the CINC of the unified command involved. Within resources available, CINCs are charged with planning for and coping with civil disturbances using resources available, and in consonance with guidance set forth by the DOD Executive Agent for this purpose. Commanders of unified commands will insure that information planning packets for all objective areas, operation plans for High Priority objective areas, and concept plans for Intermediate Priority areas are prepared.

b. Information Planning Packets (appendix 2, this annex).

I-1

~~CONFIDENTIAL~~

UNCLASSIFIED

UNCLASSIFIED

~~CONFIDENTIAL~~

ANNEX I (PLANNING) TO DEPARTMENT OF THE ARMY CIVIL DISTURBANCE  
PLAN (U)

170

- (1) A civil disturbance Information Planning Packet will be prepared for each CONUS Priority objective area as directed by CGUSCONARC (appendix 1, this annex).
- (2) Packets will be kept current.
- (3) Packets will be unclassified but will be marked FOR OFFICIAL USE ONLY.
- (4) Distribution instructions. TAB B to appendix 2, this annex.

c. Operation and Support Plans.

- (1) Operation and support plans will be prepared for each of the 25 CONUS High Priority objective areas, to include provisions for the employment of NG and designated Reserve units available in the vicinity of the objective areas.
- (2) Each designated task force commander will be furnished copies of all CONUS plans for High Priority objective areas. A primary and two alternate task force headquarters for each High Priority objective area will be designated by CGUSCONARC.
- (3) Support plans for the High Priority objective areas will be prepared when appropriate by the following headquarters as required. These headquarters will prepare, or insure the preparation of, support plans when appropriate for the High Priority objective areas as required:
  - (a) USAF
  - (b) US Navy
  - (c) USMC
  - (d) US Coast Guard
  - (e) USAMC
  - (f) USAINTC
  - (g) USCONARC

UNCLASSIFIED

I-2

~~CONFIDENTIAL~~

~~CONFIDENTIAL~~

UNCLASSIFIED

171

ANNEX I (PLANNING) TO DEPARTMENT OF THE ARMY CIVIL DISTURBANCE  
PLAN (U)

(h) USASTRATCOM

(i) MDW

(j) MTMTS

(4) Direct coordination between USCONARC and the Services, commands, or headquarters preparing support plans is authorized.

d. Concept plans will be prepared for each of the Intermediate Priority objective areas as directed by CGUSCONARC (appendix 1, this annex, and annex L).

3. (C) PLANS RESPONSIBILITIES AND APPROVAL

a. CNO, CSAF, CMC, and Comdt USCG will prepare and submit to DCDPO, for review for conformity with DOD Executive Agent policies, Service plans for civil disturbance operations. Plans will be based on, and consistent with, the DA Civil Disturbance Plan.

b. CNO, CSAF, CMC, and Comdt USCG will insure that appropriate support plans for High Priority objective areas are prepared and submitted to DCDPO, for review for conformity with DOD Executive Agent policies, and to CGUSCONARC for coordination in CONUS High Priority objective areas.

c. Unified commands involved will:

- (1) Prepare and submit to DCDPO for review for conformity with DOD Executive Agent policies, plans for civil disturbance operations as appropriate.
- (2) Insure preparation of, and approve, other plans and Information Planning Packets, as required, in areas of assigned responsibility (paragraph 2a(2), this annex).

d. DOD components, USCONARC, USAMC, USAINTC, MTMTS, and USASTRATCOM will prepare and submit to DCDPO for approval, and to CGUSCONARC for coordination, support plans for High Priority objective areas.

e. CGUSCONARC will:

- (1) Insure that required operation, support, and concept plans and Information Planning Packets for civil disturbance operations in CONUS are prepared and distributed.

I-3

~~CONFIDENTIAL~~

UNCLASSIFIED

UNCLASSIFIED

~~CONFIDENTIAL~~

ANNEX I (PLANNING) TO DEPARTMENT OF THE ARMY CIVIL DISTURBANCE  
PLAN (U)

172

- (2) Submit operation plans to DCDPO for approval as required.
- (3) Approve plans of subordinate commands for CONUS High Priority objective areas.

4. (C) INFORMATION COPIES

Plans prepared by the following commands/headquarters will be forwarded to DCDPO in four copies for information:

- a. CONUS Armies
- b. Corps
- c. Divisions
- d. Designated Task Forces
- e. MDW

5. (U) DISTRIBUTION

Appendix 3 and 4, this annex.

- Appendixes:
- 1 - Priority Objective Areas
  - 2 - Format Civil Disturbance Information  
Planning Packet  
TAB A - Map Symbols  
TAB B - Distribution of Packets
  - 3 - Services, Unified Commands, USCONARC and State  
Plans Distribution
  - 4 - Operation, Concept, Support Plans

UNCLASSIFIED

I-4

~~CONFIDENTIAL~~



173

APPENDIX 1 (PRIORITY OBJECTIVE AREAS) TO ANNEX I (PLANNING) TO DEPARTMENT OF THE ARMY CIVIL DISTURBANCE PLAN (U)

PRIORITY OBJECTIVE AREAS

1. FIRST UNITED STATES ARMY

\*High Priority

- Baltimore, MD
- Cincinnati, OH, IN, KY
- Cleveland, OH
- New York, NY
- Philadelphia, PA, MD, VA
- Washington, DC
- Boston, MA
- Louisville, KY, IN
- Newark, NJ
- Pittsburgh, PA
- Richmond, VA
- Trenton, NJ
- Wilmington, DE, PA

2. THIRD UNITED STATES ARMY

\*High Priority

- Atlanta, GA
- Memphis, TN
- Miami, FL
- Nashville, TN

3. FOURTH UNITED STATES ARMY

4. FIFTH UNITED STATES ARMY

\*High Priority

- Chicago, IL
- Detroit, MI
- Kansas City, MO
- St. Louis, MO
- Gary, IN
- Milwaukee, WI

5. SIXTH UNITED STATES ARMY

\*High Priority

- Los Angeles/Long Beach, CA
- San Francisco/Oakland, CA

APPENDIX 1 (PRIORITY OBJECTIVE AREAS) TO ANNEX I (PLANNING) TO  
DEPARTMENT OF THE ARMY CIVIL DISTURBANCE PLAN (U)

1. FIRST UNITED STATES ARMY

\*\*Intermediate Priority

Dayton, OH  
Jersey City, NJ

2. THIRD UNITED STATES ARMY

\*\*Intermediate Priority

Greensboro/Winston Salem/High Point, NC  
Jackson, MS  
Jacksonville, FL  
Raleigh, NC  
Tampa/St. Petersburg, FL

3. FOURTH UNITED STATES ARMY

4. FIFTH UNITED STATES ARMY

\*\*Intermediate Priority

Omaha, NB

5. SIXTH UNITED STATES ARMY

\*\*Intermediate Priority

San Jose, CA

1. FIRST UNITED STATES ARMY

\*\*\*Low Priority

Akron, OH  
Columbus, OH  
New Haven, CT  
Providence/Pawtucket/Warwick, RI,MA  
Rochester, NY  
Toledo, OH  
Albany/Schenectady/Troy, NY  
Atlantic City, NJ  
Bridgeport, CT  
Buffalo, NY

175

APPENDIX 1 (PRIORITY OBJECTIVE AREAS) TO ANNEX I (PLANNING) TO  
DEPARTMENT OF THE ARMY CIVIL DISTURBANCE PLAN (U)

\*\*\*Low Priority (continued)

Charleston, WV  
Erie, PA  
Hamilton/Middletown, OH  
Hartford, CT  
Lima, OH  
Newport News/Hampton, VA  
Norfolk/Portsmouth, VA  
Patterson/Clifton/Passaic, NJ  
Roanoke, VA  
Springfield/Chicopee/Holyoke, MA CT  
Stubenville/Weirton, OH, WV  
Syracuse, NY  
Waterbury, CT  
Youngstown/Warren, OH

2. THIRD UNITED STATES ARMY

\*\*\*Low Priority

Birmingham, AL  
Columbia, SC  
Durham, NC  
Mobile, AL  
Montgomery, AL  
Orlando, FL  
Tallahassee, FL  
Wilmington, NC  
Augusta, GA, SC  
Charleston, SC  
Charlotte, NC  
Chattanooga, TN, GA  
Fort Lauderdale/Hollywood, FL  
Pensacola, FL  
Savannah, GA  
Tuscaloosa, AL  
West Palm Beach, FL

3. FOURTH UNITED STATES ARMY

\*\*\*Low Priority

Baton Rouge, LA  
Little Rock/North Little Rock, AR  
New Orleans, LA  
Oklahoma City, OK

APPENDIX 1 (PRIORITY OBJECTIVE AREAS) TO ANNEX I (PLANNING) TO  
DEPARTMENT OF THE ARMY CIVIL DISTURBANCE PLAN (U)

\*\*\*Low Priority (continued)

- Pine Bluff, AR
- Albuquerque, NM
- Dallas, TX
- Houston, TX
- San Antonio, TX
- Shreveport, LA
- Tulsa, OK
- Waco, TX

4. FIFTH UNITED STATES ARMY

\*\*\*Low Priority

- Grand Rapids, MI
- Indianapolis, IN
- Kalamazoo, MI
- Muskegon/Muskegon Heights, MI
- Racine, WI
- South Bend, IN
- Wichita, KS
- Denver, CO
- Des Moines, IA
- Flint, MI
- Jackson, MI
- Lansing, MI
- Minneapolis/St. Paul, MN
- Peoria, IL
- Rockford, IL
- Saginaw, MI
- Topeka, KS
- Waterloo, IA

5. SIXTH UNITED STATES ARMY

\*\*\*Low Priority

- Phoenix, AZ
- Portland, OR, WA
- Sacramento, CA
- San Diego, CA
- Tucson, AZ
- Anaheim/Santa Ana/Garden Grove, CA
- Fresno, CA

~~FOR OFFICIAL USE ONLY~~

177

APPENDIX 1 (PRIORITY OBJECTIVE AREAS) TO ANNEX I (PLANNING) TO  
DEPARTMENT OF THE ARMY CIVIL DISTURBANCE PLAN (U)

\*\*\*Low Priority (continued)

Seattle/Everett, WA  
Stockton, CA  
Tacoma, WA

- \* High Priority - Information Planning Packets, Operation Plans, and Support Plans required.
- \*\* Intermediate Priority - Concept Plans and Information Planning Packets required.
- \*\*\* Low Priority - Information Planning Packets required.

I-1-5

~~FOR OFFICIAL USE ONLY~~



0

179

APPENDIX 2 (FORMAT - CIVIL DISTURBANCE INFORMATION PLANNING PACKET)  
TO ANNEX I (PLANNING) TO DEPARTMENT OF THE ARMY CIVIL DISTURBANCE  
PLAN (U)

SECTION 1

INTRODUCTION

- a. Purpose of Packet.
- b. Metropolitan Area Study (abbreviated)
  - (1) Geography
  - (2) Population
  - (3) Vital Statistics
  - (4) Government
- c. Recent (5 year) history of civil disturbance.
- d. Status of riot control equipment and training of police, and existence of special riot control police groups.
- e. Graphic portrayal of significant crime and fire statistics for past three years.

SECTION 2

DIRECTORY

a. Federal Agencies:

<u>AGENCY</u>	<u>LOCATION(s)</u>	<u>TELEPHONE NUMBER(s)</u>	<u>OFFICIALS</u>
Federal Bureau of Investigation			
Federal Aviation Agency			
Dept of Justice, U.S. Attorney U.S. Marshal			
Dept of Health, Education and Welfare			

APPENDIX 2 (FORMAT - CIVIL DISTURBANCE INFORMATION PLANNING PACKET)  
TO ANNEX I (PLANNING) TO DEPARTMENT OF THE ARMY CIVIL DISTURBANCE  
PLAN (U)

a. Federal Agencies (cont'd):

<u>AGENCY</u>	<u>LOCATION(s)</u>	<u>TELEPHONE NUMBER(s)</u>	<u>OFFICIALS</u>
Federal Communica- tions Commission			
U. S. District Court Judge			
USA units, Reserve tng cen (include ROTC), MI, CID, recruiting offices, & USA District Engineer			
Active U. S. Air Force facilities & units			
Department of Navy facilities & units			
Dept of Transporta- tion (Coast Guard units & facilities)			
Army Air Defense sites & Command Posts, adjacent to or within the city			
Service & Veterans Admin- istration hospitals			
State & Local medical facilities			

b. State, County, and Township Agencies:

<u>AGENCY</u>	<u>LOCATION(s)</u>	<u>TELEPHONE NUMBER(s)</u>	<u>OFFICIALS</u>
Army NG units & armories			



~~FOR OFFICIAL USE ONLY~~

181

APPENDIX 2 (FORMAT - CIVIL DISTURBANCE INFORMATION PLANNING PACKET)  
TO ANNEX I (PLANNING) TO DEPARTMENT OF THE ARMY CIVIL DISTURBANCE  
PLAN (U)

b. State, County, and Township Agencies (cont'd):

<u>AGENCY</u>	<u>LOCATION(s)</u>	<u>TELEPHONE NUMBER(s)</u>	<u>OFFICIALS</u>
Air NG units & bases			
State Alcoholic Control Office			
State Civil Defense Headquarters & local office			
State Police Head quarters & local offices			
State Attorney General's Office			
Other Agencies as appropriate			
State Defense Forces (Inactive NG & others)			

c. Municipal Agencies

<u>AGENCY</u>	<u>LOCATION(s)</u>	<u>TELEPHONE NUMBER(s)</u>	<u>OFFICIALS</u>
Mayor's Office			
Fire Department (all districts)			
Police Headquarters			
Police Stations (all precincts)			
Detention facilities			
Public Works			

I-2-3

~~FOR OFFICIAL USE ONLY~~

~~FOR OFFICIAL USE ONLY~~

182

APPENDIX 2 (FORMAT - CIVIL DISTURBANCE INFORMATION PLANNING PACKET)  
TO ANNEX I (PLANNING) TO DEPARTMENT OF THE ARMY CIVIL DISTURBANCE  
PLAN (U)

c. Municipal Agencies (cont'd)

<u>AGENCY</u>	<u>LOCATION(s)</u>	<u>TELEPHONE NUMBER(s)</u>	<u>OFFICIALS</u>
Waterworks			
School Systems			
City Engineer			
Sheriff's Office			
Directors & City Hospitals			
Director & Civil Defense Office(s)			
Other agencies as appropriate			
Police & Fire Dept Communication & location of radio repeater station(s)			

d. Commercial Firms

<u>FIRM</u>	<u>LOCATION(s)</u>	<u>TELEPHONE NUMBER(s)</u>	<u>OFFICIALS</u>
Electric Power Co & Sub-Stations			
Gas Company			
Telephone & Tele- communications Centrals			
Western Union			
Medical Supply			
Radio Station(s)			
TV Station(s)			

~~FOR OFFICIAL USE ONLY~~

FOR OFFICIAL USE ONLY

183

APPENDIX 2 (FORMAT - CIVIL DISTURBANCE INFORMATION PLANNING PACKET)  
TO ANNEX I (PLANNING) TO DEPARTMENT OF THE ARMY CIVIL DISTURBANCE  
PLAN (U)

d. Commercial Firms (cont'd)

<u>FIRM</u>	<u>LOCATION(s)</u>	<u>TELEPHONE NUMBER(s)</u>	<u>OFFICIALS</u>
Bus Company(s)			
Railroads			
Sanitation Company(s)			
Taxi Company(s)			
Hospitals & Clinics (other than city)			
Others as appropriate			

e. Foreign Agencies

<u>AGENCY</u>	<u>LOCATION (s)</u>	<u>TELEPHONE NUMBER(s)</u>	<u>OFFICIALS</u>
Foreign Embassies, Legations & Consulates			
Foreign Military Liaison Groups			

f. Personalities

List clergymen, civic leaders, social workers, political leaders, and labor leaders prominent in group relations.

SECTION 3

FACILITIES

a. Airfields

- (1) Location
- (2) Capacity (relate to Army aircraft and USAF C130 and C141 aircraft)

I-2-5

FOR OFFICIAL USE ONLY

FOR OFFICIAL USE ONLY

APPENDIX 2 (FORMAT - CIVIL DISTURBANCE INFORMATION PLANNING PACKET)  
TO ANNEX I (PLANNING) TO DEPARTMENT OF THE ARMY CIVIL DISTURBANCE  
PLAN (U)

184

- a. Airfields (cont'd)
  - (3) Controller Frequency
  - (4) Other appropriate data
- b. Troop Assembly areas (specify indoor or outdoor).
  - (1) Location
  - (2) Square footage or acreage
  - (3) Sanitation facilities
  - (4) Control authority
- c. Potential helicopter landing zones
  - (1) Location
  - (2) Clear area/airspace dimensions in feet
  - (3) Prominent reference point (identify reference; distance and azimuth from landing zone)
- d. Transportation terminals
- e. Key government buildings
- f. Sensitive areas (arms and explosive factories, commercial fuel storage facilities not to include service stations, arms and munitions storage areas to include NG and ROTC armories, gun stores and pawn shops, and other like major areas requiring security from pilferage or sabotage).

SECTION 4

COUNTERINTELLIGENCE SUMMARY

- a. A narrative, current summary of publicized agitation groups, their leaders, bases of operations, spheres of influence, grievances or propaganda themes, following and relative strengths. This summary is not an estimate, and will not contain classified information.

I-2-6

FOR OFFICIAL USE ONLY

185

APPENDIX 2 (FORMAT - CIVIL DISTURBANCE INFORMATION PLANNING PACKET)  
TO ANNEX I (PLANNING) TO DEPARTMENT OF THE ARMY CIVIL DISTURBANCE  
PLAN (U)

b. A map overprint or sketch showing the most likely areas within the city for serious disturbance to occur.

SECTION 5

MAPS

The preparation of map products for inclusion in planning packets will be completed in accordance with the following specifications:

- (1) Standard AAA or other commercial maps will be used as a base map for city plan, with intelligence overprint recommended by CONARC. The reverse side will contain an overall geographic representation of the area. OCE/AMS will take action for use of copyrighted maps.
- (2) Planning maps (used by planning/command post operation) will be a black and white photo enlargement of the operational map. The appropriate scale will be determined by ACSI and CONARC. Thirty each of these maps used by planning headquarters will be provided by AMS.
- (3) Scale of the operational version of the maps will vary (approximately 1:15,000 to 1:25,000), (scale varies on commercial maps depending on size of city). The operational map will be printed in black with the intelligence data and a local grid reference system overprinted in red. Overprint symbolization will be established by AMS to include all maximum use of standard map symbols.
- (4) Map symbols (TAB A, this appendix).

Tabs: A - Map Symbols  
B - Distribution of Packets



187

TAB A (MAP SYMBOLS) TO APPENDIX 2 (FORMAT - CIVIL DISTURBANCE INFORMATION PLANNING PACKET) TO ANNEX I (PLANNING) TO DEPARTMENT OF THE ARMY CIVIL DISTURBANCE PLAN (U)

Police Precinct Stations



Police Precinct Boundaries



Hospitals



Assembly/Bivouac Areas



with indoor indicator



with outdoor indicator



with square footage indicator in thousands

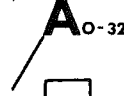

Helicopter landing areas



Fire stations



Municipal Government Control and Communications Center



Route Congestion/blockade

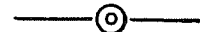

Main routes



Schools



Concentration sites equipment:

NG installations



USAR installations



I-2-A-1





189

TAB B (DISTRIBUTION OF PACKETS) TO APPENDIX 2 (FORMAT-CIVIL  
DISTURBANCE INFORMATION PLANNING PACKETS) TO ANNEX I (PLANNING)  
TO DEPARTMENT OF THE ARMY CIVIL DISTURBANCE PLAN (U)

CGUSCONARC will insure distribution of Information Planning  
Packets as follows:

	<u>Number of Copies</u>
DA/CDPO-PL	10
HQ, USAF AFXOTZC	1
COMAC	1
COMTAC	1
State AGs (packets pertaining to state)	1
CG DC NG	1
DA/ACSI	4
CG, USAINTC	3



191

APPENDIX 3 (SERVICES\*, UNIFIED COMMANDS, USCONARC, AND STATE PLANS DISTRIBUTION) TO ANNEX I (PLANNING) TO DEPARTMENT OF THE ARMY CIVIL DISTURBANCE PLAN (U)

PLAN	DISTRIBUTION							
	DA (SEE ANNEX Z)	UNIFIED COMMANDS***	DN	DAF	CMC	US COAST GUARD	USCONARC	STATE AG
JCS		2	4	4	4	4	2	
CNO		2		4	4	4	2	
DAF		2	4		4	4	6	
CMC		2	2	4		2	2	
DA (DCDPO)		4	12	12	12	12	12	2
USCONARC			12	12	12	12		2
ARMIES			2**	2	2**	2**		2**
CORPS								2**
DIVISIONS								2**
TF HQ			2**	2**	2	2**		2**
DSA			4	4	4	4	4	
DCA			4	4	4	4	4	
DIA			4	4	4	4	4	
USAINTC			2	2	2	2	4	
USASA			2	2	2	2	2	
USASTRATCOM			2	2	2	2	2	
MTMTS			2	2	2	2	2	
USAMC			2	2	2	2	2	
STATE NG			1**	1**	1**	1**	1	

- \* Service plan may contain support plans for High Priority objective area
- \*\* Distributed to Command, Headquarters, or State concerned.
- \*\*\* ALCOM, LANTCOM, PACOM, USSTRICOM.

NOTE: CGUSCONARC will determine distribution of plan to subordinate commands.



193

APPENDIX 4 (OPERATION, CONCEPT, SUPPORT PLANS) TO ANNEX I (PLANNING)  
TO DEPARTMENT OF THE ARMY CIVIL DISTURBANCE PLAN (U)

DISTRIBUTION	PREPARER & TYPE PLAN										
	UNIFIED COMMANDS*** (1) (3)	DOD COMPONENTS (3)	MDW (1)	CGUSCONARC designated Planning Agency (1)	CONUS ARMIES* (2) (3)	USAMC (3)	USAINTC (3)	USASTRATCOM (3)	MTMTS (3)	NAVAL DISTRICTS**** (3)	FMF LANT & FMF PAC (3)
DA (DCDPO)	4/4	4	4	4	4/4	4	4	4	4	4	4
USCONARC	4/4	4	4	6	5/12	2	1	2	2	4	2
ARMIES		2**	1			2	1	1	1	1	2**
CORPS			1		1/1**		1	1			
DIVISIONS			1		1/1**			1			
TF HQ			2		1/1**	1	1	1		1	2
NAVAL DISTRICTS			1		1/1**	1	1	1	1		2
E & W SEA FRON		1**	1	1	1/1**	1	1	1		2	
FMFLANT & PAC		1	1	1	1					1	
UNIFIED COMDS (Plus USEUCOM)				2**		1	1	1	1		
MDW		1**			0/1**	2	1			1	2
USAMC		2	4	2	1/1					1	2
MTMTS		2	4	2	1/1	2				1	2
USASTRATCOM		2	4	2	1/1	2				1	
USAINTC		2	2	4	4/4	2				1	2
USASA		2	1	2	1/1		3			1	2
CMC		2	4	2	4/4**	2		1	2		
DAF		4		4	2/2				4		
USCG		2	2	2**	2/2						

\*Number on the left: Operation or Concept Plan. Number on the right: Support Plan.

\*\*Pertinent plan, distributed to COMD or HQ concerned

\*\*\*ALCOM, LANTCOM, PACOM, USSTRICOM.

\*\*\*\*E & W SEA FRON coordinate Naval District Support Plans

NOTE: (1)-Operation (2)-Concept (3)-Support  
CGUSCONARC will determine distribution of plan to subordinate commands and to tasked installations of other Services.



195

ANNEX J (REPORTS) TO DA CIVIL DISTURBANCE PLAN

1. GENERAL

a. Reports covered by this annex fall into two categories:

- (1) Reports submitted to JCS in accordance with JCS Pub 6 (Joint Operational Reporting System - JOPREP).
- (2) Normal operations, personnel, logistics and intelligence reports that deal with the preparation for and execution of this plan; request for and reports of assistance furnished to civil authorities.

b. This annex prescribes the reports required, their formats and the situations and conditions under which they are to be submitted.

2. REPORTS REQUIRED

- a. Reports required by JCS Pub 6 - Appendix 1.
- b. Plans Status Report - Appendix 2.
- c. Task Force Movement Summary - Appendix 3.
- d. Personnel Status Report - Appendix 4.
- e. Logistic Status Report - Appendix 5.
- f. Initial Closing Report - Appendix 6.
- g. Situation Report - Appendix 7.
- h. Spot Intelligence Report - Appendix 8.
- i. Spot Intelligence Report (Abbreviated) - TAB A to Appendix 8.
- j. Status of Information Planning Packets - Appendix 2.
- k. Daily Intelligence Summary - Appendix 9.
- l. Report of Civil Disturbance Operations Cost - Appendix 10.
- m. After Action Report - Appendix 11.
- n. Civil Disturbance Status Report - Appendix 12.
- o. Movement Requirements and Data - Appendix 13
- p. Request and Report Format - Appendix 1 to annex K.

ANNEX J (REPORTS) TO DEPARTMENT OF THE ARMY CIVIL DISTURBANCE PLAN (U)

196

3. REPORTS CONTROL

Report Control Symbol for reports required by this plan, or any future revision, is RCS-DCDPO-1, which supersedes report control symbols CSGPO 285 and 305.

- Appendixes:
- 1 - Joint Operational Reporting System
  - 2 - Plans Status Report
  - 3 - Task Force Movement Summary
  - 4 - Personnel Status Report
  - 5 - Logistic Status Report
  - 6 - Initial Closing Report
  - 7 - Situation Report
  - 8 - Spot Intelligence Report

Tab A - Abbreviated Spot Intelligence Report

- 9 - Daily Intelligence Summary
- 10 - Report of Civil Disturbance Operations Costs

Tab A - Report of Civil Disturbance Operations  
Costs - Army

- 11 - After Action Report
- 12 - Civil Disturbance Status Report
- 13 - Movements Requirements and Data



197

APPENDIX 1 (JOINT OPERATIONAL REPORTING SYSTEM) TO ANNEX J (REPORTS)  
TO DEPARTMENT OF THE ARMY CIVIL DISTURBANCE PLAN (U)

References

- a. DOD Directive 3025.12.
- b. JCS Publication 6.

1. BACKGROUND

a. Reference a provides for the release of forces by the JCS from unified commands to the Military Departments for civil disturbance operations. Unified commanders continue to have primary interest in the status of released forces although OPCON of these forces may pass to CofSA (or commanders designated by the JCS in civil disturbance operations outside of CONUS).

b. Reference b tasks unified commanders with required reports notwithstanding OPCON of forces by another commander during civil disturbance operations.

2. REPORTS REQUIRED

Attention is directed to reference b for details and requirements pertinent to JOPREPS. Military Services and CINCs of unified commands will submit required reports, to include reports covering forces released for civil disturbance operations.



199

APPENDIX 2 (PLANS STATUS REPORT) TO ANNEX J (REPORTS) TO DEPARTMENT OF THE ARMY CIVIL DISTURBANCE PLAN (U)

1. PLANS STATUS

A report of the status of plans will be submitted to DA/DCDPO as follows.

a. Preparing Agency: USCONARC.

b. Frequency: Semi-annual, 1 April and 1 October for complete report. Changes will be submitted monthly.

c. Due date and period covered: Monthly changes will be submitted by message to DA/DCDPO by the 10th of each month for the preceding month. Semi-annual reports will be submitted by letter to DA/DCDPO by the 15th of April and 15th of October.

2. FORMAT

The report will provide information on the status of all plans for all High, Intermediate, and Low Priority cities. Example:

<u>OPLAN</u>	<u>PLANNING AGENCY</u>	<u>LATEST EFFECTIVE</u>
High Priority		
Chicago, IL	III Corps	OPLAN 563, Chicago, dtd 6 Aug 68
Boston, MA	XVIII ABN Corps	OPLAN 563, Boston, dtd 9 Aug 68; Change 3 dtd 15 Nov 68

<u>CONCEPT PLANS</u>	<u>PLANNING AGENCY</u>	<u>LATEST EFFECTIVE</u>
Intermediate Priority		
Dayton, OH	FIRST US Army	Plan dtd 3 Aug 68
Jersey City, NJ	FIRST US Army	Change dtd 1 Nov 68

<u>INFORMATION PLANNING PACKETS</u>	<u>STATUS</u>
High Priority	All completed & distributed
Intermediate Priority	All completed & distributed
Low Priority	All completed & distributed except: Ft Worth - 95% complete; Baton Rouge - 60% complete



1. Introduction

2. Methodology

3. Results

4. Discussion

5. Conclusion



201

APPENDIX 3 (TASK FORCE MOVEMENT SUMMARY) TO ANNEX J (REPORT)  
TO DEPARTMENT OF THE ARMY CIVIL DISTURBANCE PLAN (U)

TASK FORCE MOVEMENT SUMMARY REPORT

1. PURPOSE

A task force movement summary report will be submitted to the CofSA for the purpose of providing information on the actual movement status of designated forces. Unit requirements for movements planning are included in Appendix 13.

2. FREQUENCY OF REPORTING

The report will be submitted on the hour or as directed.

3. PREPARING AGENCY

The report will be prepared by the Movements Augmentation Team of the Civil Disturbance Command Center, and will list the units assigned to each task force with pertinent data concerning the status of movement of the units to the objective area (s) or home station (s). The report will include necessary data from reports prescribed in paragraph 4, below. Report format is attached at TAB A this appendix.

4. REPORTING RESPONSIBILITIES

a. Department of Air Force provide to the Department of Army (CDPO-OPS-M) the following data during deployment and redeployment:

- (1) Initial Report - This report submitted prior to commencement of operation.
  - (a) Aircraft Planned (Primary and Spares).
  - (b) Force to be airlifted.
    1. Troops.
    2. Cargo, in tons.
  - (c) Onload station.
  - (d) Offload station.
  - (e) Planned sorties for task force (by Task Force Hq, Bde Hq and battalion size units).

APPENDIX 3 (TASK FORCE MOVEMENT SUMMARY) TO ANNEX J (REPORTS)  
TO DEPARTMENT OF THE ARMY CIVIL DISTURBANCE PLAN (U)

- (f) Estimated time to close task force by Hq and battalion element.
- (2) Airlift Summary - Hourly (as-of-time on the hour) or as directed.
  - (a) Unit airlifted (Task Force Hq or Bde size units).
  - (b) Number of aircraft planned for unit move.
  - (c) Time of take-off first aircraft.
  - (d) Estimated closure time of unit.
  - (e) Onload and offload station.
  - (f) Mission identifier.
  - (g) Number of missions, troops, and tons planned.
  - (h) Number of missions, troops, and tons departing onload station.
  - (i) Number of missions, troops, and tons remaining to be operated and airlifted from onload station.
  - (j) Number of missions, troops and tons arriving offload station.
- (3) Air Movement - Hourly (as-of-time on the hour) or as directed. This report may be cancelled during certain circumstances such as widespread, fast moving civil disturbances.
  - (a) Mission identifier of unit being supported.
  - (b) Supporting airlift command, type aircraft.
  - (c) Aircraft call sign for each mission.
  - (d) Scheduled departure time of each mission.
  - (e) Actual departure time of each mission.
  - (f) Estimated and actual arrival time of each mission.
  - (g) Number of troops and tons of cargo airlifted each mission.

J-3-2

201A

APPENDIX 3 (TASK FORCE MOVEMENT SUMMARY) TO ANNEX J (REPORT)  
TO DEPARTMENT OF THE ARMY CIVIL DISTURBANCE PLAN (U)

- (h) Cumulative troops and tons of cargo departing on-load and arriving offload by Task Force Hq and Bde. The last sortie of each battalion departing onload base will be indicated on the report.
- (4) Final Report - This is a summary report and is submitted after completion of the overall operation. Report includes data by Task Force Hq and Bde.
  - (a) Sorties - planned vs actual.
  - (b) Troops - planned vs actual.
  - (c) Cargo - planned vs actual.
  - (d) Closure - planned vs actual.
  - (e) Primary Airlift Aircraft - planned vs actual.
- b. CGUSCONARC reply to queries as required. Direct Departure Airfield Control Groups (DACG's) and Arrival Airfield Control Groups (AACG's) to provide appropriate information contained in paragraph 4a(2) and (3) concerning ground forces to USAF Airlift Control Elements (ALCE's) for ALCE reporting through USAF channels. Report status of unit movement by surface (including battalion size units) to DA-CDPO-OPS-M on an hourly basis (as-of-time on the hour) or as directed. Use format TAB A this appendix for reporting data.
- c. Military Traffic Management and Terminal Service (MIMTS) report status and utilization of commercial surface transportation as directed.









205

APPENDIX 4 (PERSONNEL STATUS REPORT) TO ANNEX J (REPORTS) TO  
DEPARTMENT OF THE ARMY CIVIL DISTURBANCE PLAN (U)

PERSONNEL STATUS REPORT (PERSTAT)

1. PURPOSE

Upon commitment of Federal forces for civil disturbance operations, a personnel status report (PERSTAT) will be submitted for the purpose of keeping DA/CDCC informed of the personnel status of deployed ground forces.

2. PREPARING AGENCY

The task force commander will submit initial report to DA/CDCC as soon as the task force headquarters is operational in the objective area.

3. SUBSEQUENT REPORT SUBMISSIONS

- a. Frequency: Twice daily.
- b. Method of transmission and routing: By telephone and message. Telephone to the DA/CDCC.
- c. Due date, period covered or "as of" date: Reports will be as of 2400Z and 1200Z and telephoned to DA/CDCC NLT 0500Z and 1700Z respectively.

4. PREPARATION INSTRUCTIONS

Reports will provide personnel status of committed forces as follows:

- a. Task Force Strength Report: Report each brigade, separate battalion, and separate company by Service. Report National Guard forces and Reserve forces separately from active Federal forces. Smaller elements or provisional detachments made up for the support of the task force will be included in the strength of the task force headquarters. After initial report, indicate changes since last report.

<u>Deployed Strength</u>	<u>OFF</u>	<u>WO</u>	<u>ENL</u>	<u>AGGREGATE</u>
Unit (Active Federal Forces)				
Total (Active Federal Forces)				
Unit (NG/Reserve)				
Total (NG/Reserve)				

APPENDIX 4 (PERSONNEL STATUS REPORT) TO ANNEX J (REPORTS) TO DEPARTMENT OF THE ARMY CIVIL DISTURBANCE PLAN (U)

b. Casualty Report (Chapter 7, AR 600-10):

(1) Deaths

	<u>SINCE LAST REPORT</u>					<u>CUMULATIVE TOTAL</u>				
	A	B	C	D	E	A	B	C	D	E
Civilian										
Police										
Firemen										
Military										
Active Federal Forces by Service										
NG/Reserves by Service										

(2) Injured

	<u>SINCE LAST REPORT</u>					<u>CUMULATIVE TOTAL</u>				
	A	B	C	D	E	A	B	C	D	E
Civilian										
Police										
Firemen										
Military										
Active Federal Forces by Service										
NG/Reserve Forces by Service										

LEGEND:

- A - Gun Shot
- B - Accident
- C - Violence
- D - Fire
- E - Other (Specify)

207

APPENDIX 4 (PERSONNEL STATUS REPORT) TO ANNEX J (REPORTS) TO  
DEPARTMENT OF THE ARMY CIVIL DISTURBANCE PLAN (U)

(3) Hospitalized Since Last Report                      Total Now Hospitalized

Civilian

    Police

    Firemen

Military

    Active Federal Forces by Service

    NG/Reserve Forces by Service

Indicate by asterisk any casualty that is not the result of  
civil disturbance.

c. Missing Persons: (reported by civilian police)

d. AWOL: Report AWOL that occur after unit is alerted by Service  
and Unit.

SINCE LAST REPORT                      CUMULATIVE TOTAL                      TOTAL NOW AWOL

e. Arrests/Detained:

(1) Since last report \_\_\_\_\_.

(2) Cumulative report \_\_\_\_\_.

f. Detained in Service operated facilities:

(1) Since last report \_\_\_\_\_.

(2) Cumulative report \_\_\_\_\_.

5. MORALE AND WELFARE

To be submitted by USCONARC to DA/CDCC.

1971-1972

1971-1972

~~FOR OFFICIAL USE ONLY~~

209

APPENDIX 5 (LOGISTIC STATUS REPORT) TO ANNEX J (REPORTS) TO  
DEPARTMENT OF THE ARMY CIVIL DISTURBANCE PLAN (U)

LOGISTIC STATUS REPORT (LOGSTAT)

1. GENERAL

When directed, a logistic status report (LOGSTAT) will be submitted from task force through channels to DA/CDCC, for the purpose of keeping this headquarters informed of the logistic status of committed forces.

a. Preparing Agency: CONUSA/MDW Commanders in whose area forces are deployed. Report will be submitted through USCONARC/USARSTRIKE to the DA/CDCC.

b. Frequency: Daily.

c. Due date, period covered, and "as of" date: Reports will be as of 0400Z of the initial day that forces are committed, and as of 0400Z each day thereafter. Reports will be telephoned to the DA/CDCC, DCSLOG Representative (OX 50441 - ext 250) NLT 0800Z for the "as of" period, and confirmed by message afterward. Message confirmation will be NLT 1200Z.

2. SUPPLY STATUS IN DEPLOYMENT

Report will provide information concerning supply status of forces deployed as follows:

a. Supplies:

(1) Class I - type ration currently provided forces.

(2) Class V.

(a) Small arms.

1. Rounds (all types) on hand.

2. Rounds (all types) expended (cumulative on daily basis).

(b) Riot Control munitions.

1. Grenade, hand, riot CS (by type) on hand.

2. Grenade, hand, riot CS (by type) expended (cumulative on daily basis).

J-5-1

~~FOR OFFICIAL USE ONLY~~

APPENDIX 5 (LOGISTIC STATUS REPORT) TO ANNEX J (REPORTS) TO  
DEPARTMENT OF THE ARMY CIVIL DISTURBANCE PLAN (U)

3. SUPPLY STATUS IN OBJECTIVE AREA

Provide information as to supply status in the objective area concerning:

- a. General purpose vehicles (exclude trailers) with forces.
- b. Special purpose vehicles (specify) with forces.
- c. Tanks and APC's with forces.
- d. Vehicles (by type, i.e., sedan, bus, truck) procured from commercial sources.
- e. Riot control weapons M3 (M106) and M5 Dispensers with forces.
- f. Army aircraft with forces as:
  - (1) Fixed Wing, by type.
  - (2) Helicopters, by type.

4. SHORTAGES

Report significant shortages of supplies/munitions and/or equipment which affect, or may affect, the accomplishment of the mission. Report action taken.

5. MAINTENANCE DEFICIENCIES

Report major maintenance deficiencies which cannot be resolved with available resources.

6. PROBLEMS

Report problems in the area of services which cannot be resolved locally.

7. SPECIAL INSTRUCTIONS

1. Report "not applicable (N/A)" for subparagraphs as appropriate.
2. After the initial report, indicate "no change" for each subparagraph as applicable.



211

APPENDIX 6 (INITIAL CLOSING REPORT) TO ANNEX J (REPORTS) TO  
DEPARTMENT OF THE ARMY CIVIL DISTURBANCE PLAN (U)

INITIAL CLOSING REPORT

1. PURPOSE

An initial closing report will be submitted to DA/CDCC for the purpose of keeping DA informed of the status of ground forces during deployment and redeployment to and from the objective area.

a. Preparing Agencies: The CG, USCONARC, will report on ground forces closing in the objective areas during the deployment phase and home stations during redeployment phase.

b. Frequency: As forces close during deployment and redeployment phase.

c. Reports will be submitted by telephone to DA/CDCC forces as soon as possible after closing time.

2. CONTENT

The report will provide the following information:

- a. Unit designation.
- b. Strength.
- c. Closing time.
- d. Closing location.

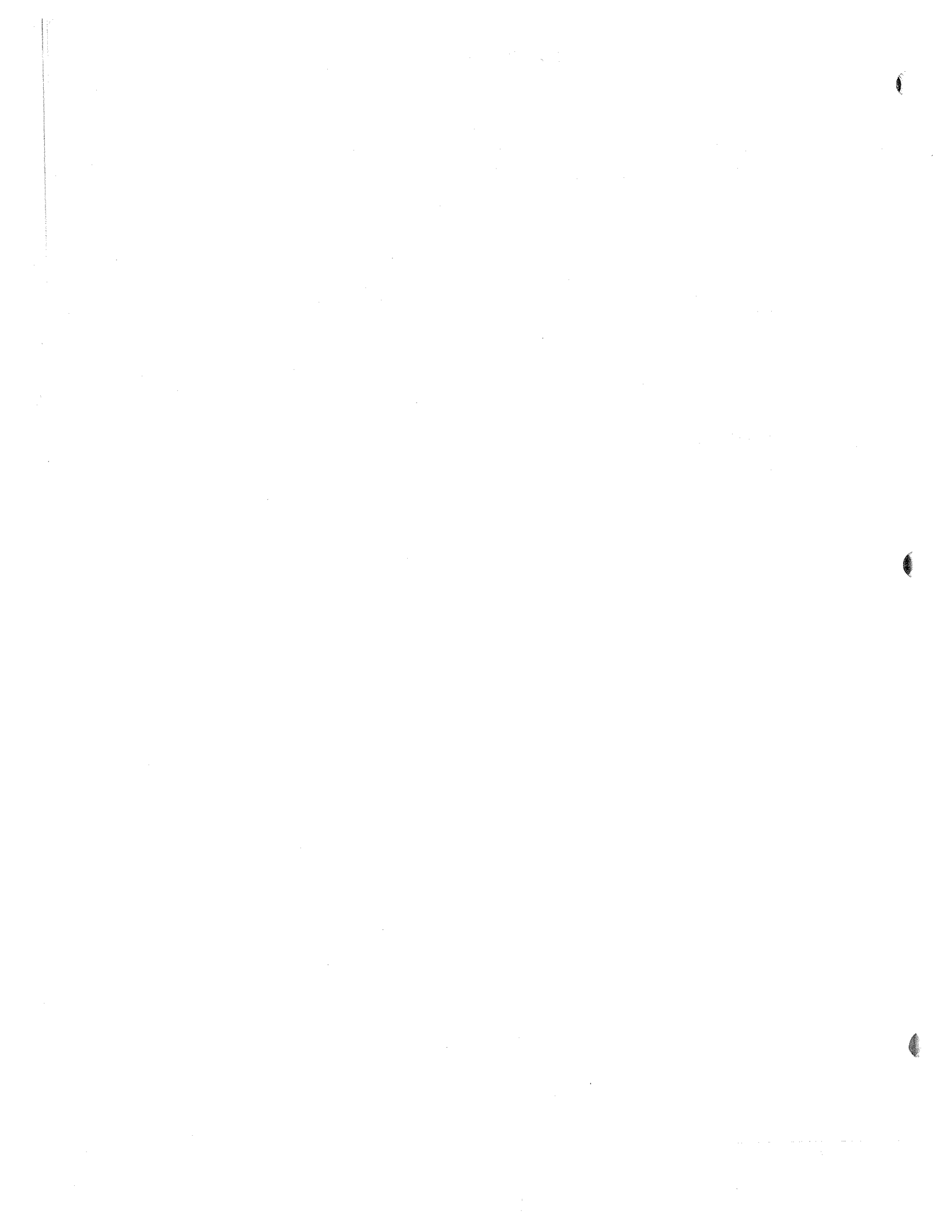

213

APPENDIX 7 (SITUATION REPORT) TO ANNEX J (REPORTS) TO DEPARTMENT  
OF THE ARMY CIVIL DISTURBANCE PLAN (U)

SITUATION REPORT (SITREP)

1. GENERAL

Situation reports will be submitted to DA/CDCC to provide information to this headquarters on the conduct of civil disturbance operations.

a. Preparing Agency: Committed task force.

b. Frequency: Twice daily.

c. Due date, period covered and "as of" date. Reports will be submitted as of 1000Z and 2000Z and are due to DA/CDCC representative not later than 1200Z and 2200Z respectively for the "as of" date. Reports may be by telephone or message. Telephonic reports will be confirmed by message.

2. FORMAT

Reports will be in the format as follows:

Subject: SITREP (Number) as of (date/time)

Reporting Period: 0001-2400 Hrs.

TASK FORCE NAME

1. INTELLIGENCE SITUATION

2. OPERATIONS

3. PERSONNEL

4. LOGISTICS

5. COMMUNICATIONS

A "no change" will be submitted on any of the above as applicable.



215  
APPENDIX 8 (SPOT INTELLIGENCE REPORT) TO ANNEX J (REPORTS) TO  
DEPARTMENT OF THE ARMY CIVIL DISTURBANCE PLAN (U)

SPOT INTELLIGENCE REPORT (SPIREP)

1. PURPOSE

Spot intelligence reports are submitted for the purpose of keeping all headquarters that may be involved in civil disturbance operations informed of pertinent activities throughout CONUS. An abbreviated format is used during rapidly developing situations (TAB A, this appendix).

a. Preparing Agencies:

- (1) MI Group in each Army Area.
- (2) Committed task force.

b. Reports will be submitted to DA/CDCC Headquarters as soon as possible after receipt of information. Reports will be transmitted either electrically or telephonically.

2. FORMAT

The reports will contain the information as applicable and/or available in the following format:

- a. From.
- b. Spot Report Number.
- c. Subject.
- d. Reference to previous reports.
- e. Time, date, and place.
- f. Person, organization, or installation involved.
- g. Summary.
- h. Significance and/or effect upon military installation, activity or facility.
- i. Time and date reported to Army ACS Intelligence.

~~FOR OFFICIAL USE ONLY~~

APPENDIX 8 (SPOT INTELLIGENCE REPORT) TO ANNEX J (REPORTS) TO  
DEPARTMENT OF THE ARMY CIVIL DISTURBANCE PLAN (U)

216

- j. Action taken by reporting agency.
- k. Source.
- l. Evaluation of source and information.
- m. Time and date information received by INTC (reporting agency).
- n. Comment of reporting agency.

J-8-2

~~FOR OFFICIAL USE ONLY~~

217

TAB A (ABBREVIATED SPOT INTELLIGENCE REPORT) TO APPENDIX 8 (SPOT INTELLIGENCE REPORT) TO ANNEX J (REPORTS) TO DEPARTMENT OF THE ARMY CIVIL DISTURBANCE PLAN (U)

FORMAT FOR ABBREVIATED SPOT REPORTS

1. SPOT REPORT HEADING

DATE AND TIME GP BY ORIGINATOR: (ZULU Time)

FROM: MI Group originating spot report

TO: ADDRESSEES (Both action and info addressees)

2. SPOT REPORT NUMBER

(Operational guidance: Numerical sequence by originator insures continuity of reporting and sequence of events as they occur. Reference to previous spot reports on events reported should follow in parentheses.)

3. SUMMARY OF ACTIVITIES

(Operational guidance: Brief narrative of events permits the reporting of fast-breaking events in connection with the demonstration or the outbreak of civil disorder in connection with the demonstration. All times reported in this paragraph will be times local to the scene of the incident.)

4. SOURCE(S)

(Operational guidance: Indicate whether information furnished by a military special agent reporting "on the scene" coverage, or information furnished by another local, state or federal law enforcement or investigative agency.)

5. FIELD EVALUATION

(Operational guidance: Alphabetical (A thru F) for evaluation source. Numerical (one thru six) for evaluation of the information.)

6. OPERATIONAL COMMENT

(Operational guidance: To be utilized by reporting MI Group for observations by the special agent "on the scene" or comments which did not necessarily relate or lend themselves to inclusion within the summary of activities. This sub-heading also provides a means for transmitting operational comments and/or recommendations to action addressees such as the Army Operations Center, DA, and to other headquarters.)

J-8-A-1

~~FOR OFFICIAL USE ONLY~~

TAB A (ABBREVIATED SPOT INTELLIGENCE REPORT) TO APPENDIX 8 (SPOT INTELLIGENCE REPORT) TO ANNEX J (REPORTS) TO DEPARTMENT OF THE ARMY CIVIL DISTURBANCE PLAN (U)

218

7. ADDITIONAL DISSEMINATION

(Operational guidance: Include identities of agencies to whom a copy of the spot report has been furnished such as through liaison contact or by courier.)

J-8-A-2

~~FOR OFFICIAL USE ONLY~~



219

APPENDIX 9 (DAILY INTELLIGENCE SUMMARY) TO ANNEX J (REPORTS)  
TO DEPARTMENT OF THE ARMY CIVIL DISTURBANCE PLAN (U)

DAILY INTELLIGENCE SUMMARY (DISUM)

1. PURPOSE

Daily intelligence summaries will be submitted to DA/CDCC for the purpose of providing this headquarters with intelligence in the objective area.

a. Preparing Agency:

- (1) Committed task forces.
- (2) CONUS Armies and MDW.

b. Frequency: Twice daily.

c. Due date, period covered, and "as of" date: Reports will be as of 1200Z and 2400Z of the initial day of force commitment and each day thereafter, until termination of operation. Reports will be telephoned to the DA/CDCC ACSI representative not later than 1700Z and 0500Z respectively, for the "as of" period.

2. FORMAT

Report will provide the following information:

a. Issuing headquarters.

b. Time and date.

c. Summary of dissident activity for period.

- (1) Description of activity.
- (2) Location of activity by street boundary.
- (3) Use of unusual weapons or tactics.
- (4) Indications of centralized organization.
- (5) Other.

d. Personnel and equipment losses, dissident elements.

- (1) Personnel (KIA, WIA).
- (2) Equipment destroyed/taken.

APPENDIX 9 (DAILY INTELLIGENCE SUMMARY) TO ANNEX J (REPORTS)  
TO DEPARTMENT OF THE ARMY CIVIL DISTURBANCE PLAN (U)

220

- e. Obstacles and barriers used by dissidents.
- f. Administrative activities.
- g. Identification of dissident organizations and personalities involved.
- h. Movement of dissident groups into or out of objective area.
- i. Brief discussion of dissident groups capabilities and vulnerabilities.
- j. Conclusions.

3. SPECIAL INSTRUCTIONS

CONUS Armies and MDW will prepare reports only while task forces are operating in their Army Areas or the Military District of Washington. Information reported in USAINTC spot reports normally should not be repeated in this report; it is desired that trends be developed and analyses made.

J-9-2

221

APPENDIX 10 (REPORT OF CIVIL DISTURBANCE OPERATIONS COSTS) TO  
ANNEX J (REPORTS) TO DEPARTMENT OF THE ARMY CIVIL DISTURBANCE  
PLAN (U)

REPORT OF CIVIL DISTURBANCE OPERATIONS COSTS

1. GENERAL

a. After the termination of civil disturbance operations, a report of costs will be submitted to the Executive Agent for the purpose of reporting Consolidated Department of Defense expenses resulting from assistance provided in support of civil disturbance operations.

b. Submitting agencies:

Department of the Army

Department of the Navy

Department of the Air Force

c. These reports are to be submitted to the Directorate for Civil Disturbance Planning and Operations for consolidation and subsequent submission to the Under Secretary of the Army, who acts for the Executive Agent, the Secretary of the Army.

2. DATA REQUIRED

a. Cost reports will be submitted to include data reported separately, by appropriation, for each city or location provided assistance and in total for all troops held on standby. Data will be identified by fiscal year. Costs which are reimbursable from agencies outside the Department of Defense, i.e., other U.S. Government Agencies, local governments and from another Defense component will be identified and reported on separate lines under appropriate categories. Costs shown for each individual component shall include those costs which are reimbursable to another component or agency. Thus, reported cost per component, will reflect an approximation of the ultimate direct costs for that component.

b. Following the summarized total cost of a civil disturbance at a location, a memorandum entry will be made by component of the plus and minus reimbursable adjustments, above, indicating the component, or government agency involved and the amount for each. The reimbursement for MAC airlift costs involved in adjustments will be shown as a separate line entry for each component or other agency.

J-10-1

APPENDIX 10 (REPORT OF CIVIL DISTURBANCE OPERATIONS COSTS) TO  
ANNEX J (REPORTS) TO DEPARTMENT OF THE ARMY CIVIL DISTURBANCE  
PLAN (U)

222

c. Report will reflect the number of regular Army personnel, National Guard personnel called to Federal service and Reserve personnel ordered to active duty. Strengths should be shown by location, by day. For purposes of this report an individual on duty for any part of a day is considered as being on duty for the entire day.

3. REPORTS REQUIRED

Two cost reports in the detail described above are required. The first report will be submitted to DCDPO not later than the fourth day after Headquarters, Department of the Army announces the termination of the civil disturbance operations. This initial report will contain cost information based on the best data, actual and estimated, available at the time. The second cost report will be a complete reporting of actual costs and will be submitted to DCDPO within fifteen working days after the termination of the civil disturbance.

4. DEPARTMENT OF THE ARMY COSTS. (Tab A, this appendix).

5. DEPARTMENT OF THE AIR FORCE COSTS.

Instructions are contained in Annexes N and X to the Air Force GARDEN PLOT Plan.

6. DEPARTMENT OF THE NAVY COSTS

Department of the Navy costs of civil disturbance operations will be provided by the Comptroller of the Navy who will issue necessary reporting instructions requiring submission of cost data by field installations involved in these operations.

Tab: A - Report of Civil Disturbance Operations Costs (US Army)

223

TAB A TO APPENDIX 10 (REPORT OF CIVIL DISTURBANCE OPERATIONS COSTS - ARMY)  
TO ANNEX J (REPORTS) TO DEPARTMENT OF THE ARMY CIVIL DISTURBANCE  
PLAN (U)

REPORT OF CIVIL DISTURBANCE OPERATIONS COSTS (US ARMY)

1. REQUIREMENT

After termination of a civil disturbance operation, cost\* reports will be submitted to Headquarters, DA, ATTN: COA-B(FMO), for the purpose of meeting requirements for staff information, reprogramming, or requesting additional funds to meet increased Army expenses resulting from assistance provided in support of civil disturbance operations. Data will be reported separately, by appropriation, for each city provided assistance and in total for all troops held on standby. A brief narrative explanation will be made by footnote to explain construction costs, normal costs in excess of \$500 per item, and offset credits.

2. SUBMITTING AGENCIES

All Army commands, agencies, and the Army General Staff will submit the required reports when expenses have been incurred that are attributable to civil disturbances.

3. REQUIRED COST REPORTS

Two costs reports in the detail described above are required. The first cost report will be submitted within 72 hours after Headquarters, DA announces the termination of the civil disturbance operation. This initial report will contain cost information based on the best data, actual and estimated, available at the time. The second cost report will be a complete reporting of actual costs and will be submitted within 14 days after the announced termination of the civil disturbance operation.

4. INTERIM REPORTS

Interim reports may be required if a civil disturbance operation requires lengthy deployment of military forces. These interim reports, if required, will be requested by message or telephone. Interim reports will be based on the best cost information available at the time.

5. FORMAT

Formats for the reports will be as follows:

\* Costs are synonymous with obligations.

J-10-A-1

TAB A TO APPENDIX 10 (REPORT OF CIVIL DISTURBANCE OPERATIONS COSTS-  
ARMY) TO ANNEX J (REPORTS) TO DEPARTMENT OF THE ARMY CIVIL DISTURBANCE  
PLAN (U)

a. Military Personnel, Army.

- (1) Active Duty.
- (2) National Guard called to Federal service and mobilized Reserve.

TOTAL MPA

b. Procurement of Equipment and Missiles, Army.

- (1) Issues to military forces.
- (2) Assistance to other Federal agencies (identify separately by agency).

TOTAL PEMA

c. Operation and Maintenance, Army.

- (1) Temporary Duty Costs.
  - (a) Military.
  - (b) Civilian.
- (2) Civilian Overtime.
- (3) Transportation.
  - (a) USAF Transportation (reimbursable).
  - (b) USAF Transportation (non-reimbursable) (non-add, memo entry).
  - (c) Military Motor Transportation.
  - (d) Army Air Transportation.
  - (e) Commercial Transportation.
- (4) Assistance to other Federal agencies (identify separately by agency).
- (5) Support to other military Services (identify separately by Service).

225

TAB A TO APPENDIX 10 (REPORT OF CIVIL DISTURBANCE OPERATIONS COSTS-  
ARMY) TO ANNEX J (REPORTS) TO DEPARTMENT OF THE ARMY CIVIL DISTURBANCE  
PLAN (U)

- (6) Support to National Guard on state status.
- (7) Support to Civilian Law Enforcement Agencies (identify separately by agency).
- (8) Construction Costs (identify individual line items whose cost exceeds \$500 per line).
- (9) Materials and supplies.
- (10) Other O&MA Costs (identify individual line items whose cost exceeds \$500 per line).

TOTAL O&MA

d. Summary.

Gross Costs (all appropriations).

Less: Normal Costs (separate by appropriation).

Offset Credits (separate by appropriation).

Reimbursements (separate by agency).

Net Costs (all appropriations).

e. Number of military man days required. (A military man day is considered to be a calendar day regardless of hours on duty.)

NOTE: Reimbursable costs will be shown as required on a separate line, under the appropriate caption, e.g., (7) Support to Civilian Law Enforcement Agencies.





227

APPENDIX 11 (AFTER ACTION REPORT) TO ANNEX J (REPORTS) TO  
DEPARTMENT OF THE ARMY CIVIL DISTURBANCE PLAN (U)

AFTER ACTION REPORT

Reference

AR 525-15

1. AFTER ACTION REPORT

After action reports will be submitted to Department of the Army for the purpose of providing an historical summary of actions related to civil disturbances and a statement of problems encountered and lessons learned.

2. PREPARING AGENCIES

a. Task Forces. Units under operational control of a task force will submit input as required by the commander.

b. The following Army commands and agencies, as deemed appropriate by the commander, will prepare and submit reports:

USCONARC/USARSTRIKE

USACDC

USAINTC

USAMC

USARADCOM

USASA

USASTRATCOM

MIMTS

c. CSAF, CNO, CMC and commanders of unified commands will submit copies of reports to ACSFOR, DA and DCDPO, ATTN: CDPO-PP-P, when appropriate.

3. SUBMISSION OF REPORTS

After action reports will be prepared and submitted to ACSFOR, DA, within 15 days of release of a task force from a civil disturbance mission; reports of other Services, commands, and agencies will be submitted within 15 days of termination of

J-11-1

APPENDIX 11 (AFTER ACTION REPORT) TO ANNEX J (REPORTS) TO  
DEPARTMENT OF THE ARMY CIVIL DISTURBANCE PLAN (U)

civil disturbance operations. A copy will be provided separately to the Directorate for Civil Disturbance Planning and Operations, ATTN: CDPO-PP-P.

4. CONTENT OF REPORTS

Commanders submitting reports should give special emphasis to noting shortcomings and successes which contribute to a lesson learned and which indicate a need for changes in doctrine, training, techniques, or procedures. Any improvisation, innovation, expedient, or stratagem successfully employed as well as problems and solutions to problems of intelligence and coordination with local authorities should be described.

J-11-2

229

APPENDIX 12 (CIVIL DISTURBANCE STATUS REPORT) TO ANNEX J (REPORTS)  
TO DEPARTMENT OF THE ARMY CIVIL DISTURBANCE PLAN (U)

CIVIL DISTURBANCE STATUS REPORT (CIDSTAT)

Reference

AR 525-10

1. PURPOSE

The Civil Disturbance Status Report (CIDSTAT) gives the status of military units which may be employed in civil disturbance operations.

2. SUBMISSION

The CIDSTAT is submitted to DA/CDCC as of the first of each month to arrive not later than the 10th of each month. Initial reports will be submitted as of 1 September 1968 with all change data submitted each month thereafter.

3. RESPONSIBILITIES

The CIDSTAT will be prepared for all forces assigned for civil disturbance operations and submitted by:

- a. USCONARC for all Army active and mobilized Reserve units.
- b. NGB for all Army NG units with a civil disturbance mission.
- c. CNO for all Navy active and mobilized Reserve units.
- d. CSAF for all Air Force active called NG, and mobilized Reserve units.
- e. CMC for all Marine active and mobilized Reserve units.

4. INFORMATION COPIES

Information copies of reports prepared will be furnished CGUSCONARC.

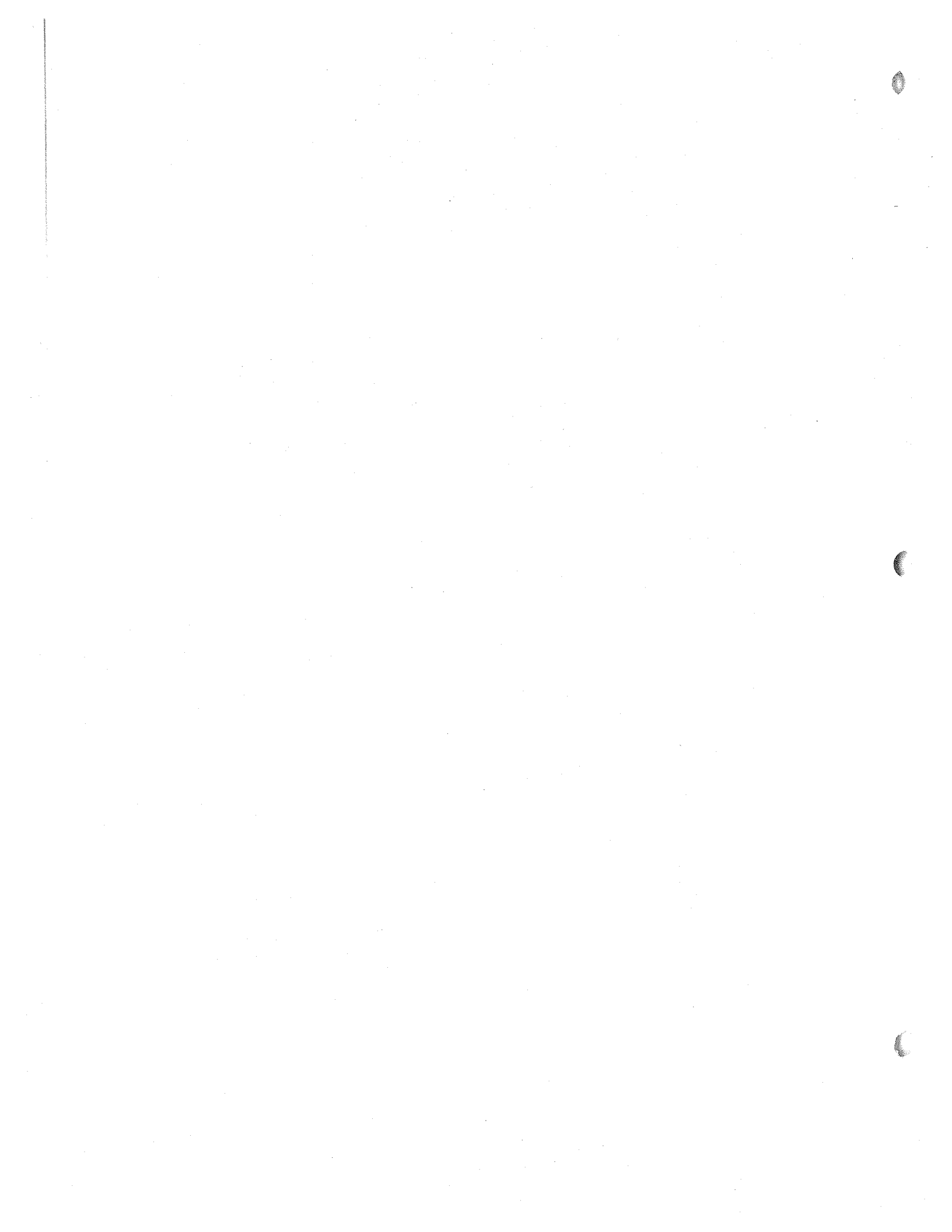

231

APPENDIX 13 (MOVEMENTS REQUIREMENTS AND DATA) TO ANNEX J (REPORTS)  
TO DEPARTMENT OF THE ARMY CIVIL DISTURBANCE PLAN (U)

MOVEMENTS REQUIREMENTS REPORT

1. PURPOSE

Movements requirements will be submitted thru CDPO-CDCC to CDPO-OPS-M for the purpose of developing closure times and number of sorties prior to any planned movement of GARDEN PLOT forces to an objective area.

2. PREPARING AGENCY

USCONARC will submit the requirements which include the following data:

- a. Unit designation and location.
- b. Alert Posture (when alerted or when available at onload airfield).
- c. Number of personnel.
- d. Equipment:
  - (1) Number of vehicles by type (plus loaded weight and cube).
  - (2) Number of trailers by type (plus loaded weight and cube).
  - (3) Weight and cube of other cargo (not on vehicles or trailers).

NOTE: The above data should be provided for:

- (a) TF HQ's.
- (b) STRATCOM detachments.
- (c) IRE's.
- (d) Bn (-) or Bde (-) by Bn element and Bde HQ.

3. SUBMISSION OF DATA

Data will be submitted immediately for alerted forces, and 48 hours prior to the implementation of changes to the movements requirements of alerted units. If there is no change to existing data, a negative report is required.

J-13-1



233

ANNEX K (PROVIDING RESOURCES TO CIVIL AUTHORITIES) TO DEPARTMENT  
OF THE ARMY CIVIL DISTURBANCE PLAN (U)

Reference: DOD Directive 3025.12.

1. INTRODUCTION

This annex establishes the policy and procedures whereby resources from the Department of Defense are provided to civil authorities for civil disturbance operations.

2. PROVIDING RESOURCES TO CIVIL AUTHORITIES

a. The loan of equipment is intended to meet an urgent need during an actual disorder, and such loans will be considered as a temporary emergency action. Loan agreements will state that loaned equipment may be kept only for the duration of the disorder and in no case more than 15 days. Should the disorder exceed this 15-day period, the receipt for equipment and loan agreement may be renewed for another 15 days. Requests for additional extensions must be approved by the Executive Agent. Requests for DOD facilities, personnel, equipment, or supplies received from officials of the 50 states, District of Columbia, Commonwealth of Puerto Rico, US possessions and territories, or any political subdivision thereof, for use in connection with civil disturbances will be handled as follows:

(1) Classification of Resources. Military resources will be classified into three groups, as follows:

- (a) Group One: Military personnel; or arms, ammunition, tank-automotive equipment, and aircraft.
- (b) Group Two: Military equipment of an offensive nature not included in Group One, such as riot control agents and concertina wire.
- (c) Group Three: Fire fighting equipment; equipment of a protective nature (such as masks, helmets, armored vests) and other equipment not included in Group One or Two (such as clothing, communications equipment, search lights); and the use of DOD facilities.

(2) Approval of Requests.

- (a) Requests for Group One resources may be granted only with the personal approval of the DOD Executive Agent or, when designated by him for that purpose, the Under Secretary of the Army.

ANNEX K (PROVIDING RESOURCES TO CIVIL AUTHORITIES) TO DEPARTMENT  
OF THE ARMY CIVIL DISTURBANCE PLAN (U)

234

- (b) Request for Group Two resources may be granted only with the personal approval of the DOD Executive Agent; or, when designated by him for that purpose: (a) the Under Secretary of the Army; (b) a task force commander employed at an objective area during a civil disturbance; or (c) a commander in the event of an actual civil disturbance, specifically designated to implement a contingency plan approved by the DOD Executive Agent.
  - (c) Requests for Group Three resources may be granted by Secretaries of the Military Departments, by CINCs of unified and specified commands for areas outside the CONUS, or by commanders of military service installations or organizations who have been delegated such authority by the appropriate secretary or CINC.
- (3) Denial of Requests.
- (a) Requests for Group One, Two, or Three resources may be denied at any level in the chain of command down to and including commanders delegated Group Three approval authority.
  - (b) To the maximum extent practicable, local military authorities will encourage the use of local or state resources rather than military resources.
- (4) Processing of Requests.
- (a) All requests will be promptly submitted through channels to the appropriate approving authorities using the format shown in appendix 1, this annex.
    - 1. Requests of an urgent nature will be forwarded by the most rapid means of communications available.
    - 2. Requests which are not time critical will be handled in keeping with the degree of urgency dictated by the situation.



235

ANNEX K (PROVIDING RESOURCES TO CIVIL AUTHORITIES) TO DEPARTMENT  
OF THE ARMY CIVIL DISTURBANCE PLAN (U)

- (b) Requests received by personnel of the Defense agencies will be referred to local military commanders for processing.
- (5) Loan Agreements.
  - (a) A loan agreement will be executed for all equipment loaned to civil authorities for the control of civil disturbances. The loan agreements will contain provisions for a cash bond, equivalent to the value of the loaned property, as a condition precedent to making the loan. The bond will be forfeited in the event the equipment is not returned at the times specified. Forfeiture of the bond does not constitute a sale of equipment, and the borrower will still be required to return the loaned equipment.
  - (b) Approving commanders may approve a request in anticipation of imminent threat of disorders only when the borrower has initiated procurement action and there is substantial lead time before the equipment will be received. Loan agreements executed for requests of this nature may be executed only for the period of time until the procurement delivery date. Loan agreements will contain provisions for a cash bond equivalent to the value of the equipment loaned, as a condition precedent to making the loan and will contain loan agreements as set forth above. The bond will be forfeited in the event the equipment is not returned at the time specified. Forfeiture of the bond does not constitute sale of the equipment and the borrower will still be required to return the loaned equipment.
- (6) Reporting Requests.
  - (a) Requests for military assistance from civil authorities that require DOD Executive Agent approval will be forwarded to DA/CDCC for relay to the DOD Executive Agent.
  - (b) Reports of all requests (approved, denied, or pending) will be prepared by all approval authorities, using the format shown in Appendix 1, Request and Report Format, this annex, as shown below:

ANNEX K (PROVIDING RESOURCES TO CIVIL AUTHORITIES) TO DEPARTMENT  
OF THE ARMY CIVIL DISTURBANCE PLAN (U)

236

1. To the military Department headquarters, in the case of requests received in the CONUS by the four Services.
  2. To DA/CDCC with information copies to JCS, in the case of requests received by organizations or installations over which the commanders of the unified and specified commands exercise command authority.
- (c) All reports will be transmitted to DA/CDCC for DOD Executive Agent, who, in turn, will transmit information copies of all approved requests for Groups One and Two resources to the General Counsel of the DOD and the Deputy Attorney General of the United States.
- (d) A weekly summary report of all requests will be compiled by DA/CDCC and submitted through the DOD Executive Agent to the General Counsel of the DOD, the Assistant Secretary of Defense (Installations and Logistics), and the Deputy Attorney General of the United States. This report will be submitted as of 2400Z, Wednesday, due by 2000Z, the following Sunday.

Appendix: 1 - Request and Report Format

APPENDIX 1 (REQUEST AND REPORT FORMAT) TO ANNEX K (PROVIDING  
RESOURCES TO CIVIL AUTHORITIES) TO DEPARTMENT OF THE ARMY CIVIL  
DISTURBANCE PLAN (U)

237

REQUEST AND REPORT FORMAT

1. All requests for assistance received, whether denied, approved, or forwarded for approval will be reported promptly (reports control symbol DCDPO-1) in the following format:

- a. DOD organization receiving request.
  - b. Place (city, town, village, county) of the actual or anticipated civil disturbance.
  - c. Name and title of requesting civil official.
  - d. Date time group (ZULU) request for assistance was received.
  - e. Scope of the disturbance or the threat of such a disturbance existing at the time of the request.
  - f. Type and quantities of assistance requested.
  - g. Purpose for which assistance was requested.
  - h. Anticipated duration the assistance will be required.
  - i. Anticipated impact on local community relations resulting from approval/disapproval of the request.
  - j. Statement as to whether the request was granted or denied and the level at which the decision was made.
  - k. Reasons for refusing or referring the request to higher headquarters.
    1. If request referred to higher headquarters, provide a recommendation or comments as to approval or denial based upon knowledge of facts at hand.
  - m. Provide additional information on emergency firefighting assistance provided in a civil disturbance situation.
  - n. Other pertinent information, e.g. effect on ability to perform assigned missions and if so, the extent and duration.
2. Appropriate security classification will be place on this document when completed.

K-1-1



239

ANNEX L (DEFINITIONS) TO DEPARTMENT OF THE ARMY CIVIL  
DISTURBANCE PLAN

The following definitions apply to terms used in the DA Civil Disturbance Plan and do not alter or change the usage of any word covered in JCS Pubs 1 and 2 or DOD Dir 3025.12.

DEFINITIONS

a. Airlift personnel: Air crew and ground support personnel (including all Air Force and Naval Personnel not designated as ground forces) providing airlift and air logistic support to civil disturbance operations, excluding Army and Navy helicopter crew and ground support personnel.

b. Appropriate official: For the purpose of providing military resources to civil authorities, an appropriate official of the 50 states, District of Columbia, Commonwealth of Puerto Rico, US possessions and territories, or any political subdivision thereof (see paragraph X, DOD Dir 3025.12) is an individual duly authorized to represent a city, county, state government, or law enforcement agency concerned.

c. Called National Guard. National Guard units or members who have been placed in a status of Federal active service.

d. CIDCON: Civil Disturbance Condition.

e. Commercial obligated aircraft: Civil aircraft under contract to the USAF (MAC) for airlift of military resources.

f. Concept Plan: A written outline of a commander's assumptions or intent in regard to operations in an Intermediate Priority objective area to include sufficient information upon which an operation plan can be based but excluding support plans.

g. CONUS: The 48 contiguous states and the District of Columbia.

h. Deployment: The act of moving forces to and positioning in the objective area(s).

i. Employment: The act of using forces in civil disturbance operations.

ANNEX L (DEFINITIONS) TO DEPARTMENT OF THE ARMY CIVIL  
DISTURBANCE PLAN (U)

240

j. Federal Team: A Federal Team is normally composed of: (1) a senior civilian representative as designated by the Attorney General; (2) a senior Department of Justice legal advisor; (3) a representative of the assistant Attorney General, Civil Rights Division; (4) a representative of the Director of the Community Relations Service; (5) a senior Public Affairs Officer; (6) a representative of the Director of the Bureau of the Budget to coordinate all requests for economic and social assistance to an objective area; and (7) a task force commander appointed by the CofSA to exercise operational command over all Federal ground forces designated in the objective area.

k. Ground forces: Those military forces organized, trained, and equipped for use in civil disturbance operations including Service supporting personnel for ground operations.

l. Objective areas:

- (1) For Planning - Areas specified by the CofSA or unified commander which represent potential civil disturbance areas of operation.
- (2) For Operations - Areas specified by the Presidential Proclamation and Executive Order in which the Secretary of Defense has been directed to restore law and order. The areas specified by the Proclamation and Executive Order may be further defined or limited in the Letter of Instruction to the task force commander by the CofSA or unified commander. In cases where a Proclamation and Executive Order have not been issued (e.g. the protection of Federal property) the objective area will be specified in the Letter of Instruction to the task force commander.

m. Priority objective areas: Areas identified as potential civil disturbance areas of operation. Objective areas generally consist of one or more cities or portions thereof. For planning purposes, objective areas are further identified as High, Intermediate, and Low Priority.

241

ANNEX M (MEMORANDUM OF UNDERSTANDING) TO DEPARTMENT OF THE  
ARMY CIVIL DISTURBANCE PLAN (U)

DEPARTMENT OF THE ARMY  
Office of the Chief of Staff  
Washington, D. C. 20310

DEPARTMENT OF TRANSPORTATION  
United States Coast Guard  
Washington, D.C. 20591

MEMORANDUM OF UNDERSTANDING BETWEEN THE UNITED STATES ARMY AND THE  
UNITED STATES COAST GUARD CONCERNING CIVIL DISTURBANCE PLANS AND  
OPERATIONS

This memorandum establishes policies, procedures, and guidelines relating to employment of elements of the US Coast Guard when Federal forces are committed to civil disturbance operations.

SECTION I

GENERAL

1. The operational missions of the Coast Guard are paramount; use of its resources in civil disturbance operations is contingent upon the ability of the Coast Guard to continue to perform its statutory duties.
2. In civil disturbance operations, employed Coast Guard elements will be responsive to the policies and procedures established by the Department of the Army Civil Disturbance Plan.

SECTION II

RESOURCES TO BE EMPLOYED

1. The Coast Guard will furnish such waterborne and airborne resources as are reasonably available to assist in civil disturbance operations. The Coast Guard will not be expected to form or maintain ground forces for employment in civil disturbance operations except to protect its own land facilities.
2. The Coast Guard may request assistance as required from other Federal civil disturbance forces in order to carry out its statutory obligations of securing and protecting areas over which it has jurisdiction.

ANNEX M (MEMORANDUM OF UNDERSTANDING) TO DEPARTMENT OF THE  
ARMY CIVIL DISTURBANCE PLAN (U)

242

3. The Coast Guard will provide logistical support to other Federal civil disturbance forces within the limits of locally available resources.

4. The Army will provide the Coast Guard with riot control munitions, loan of special equipment, and technical assistance if, when, and as required for civil disturbance operations.

SECTION III

COMMAND RELATIONSHIPS

The Federal civil disturbance task force commander will exercise operational control over Coast Guard elements committed to control civil disturbance through the appropriate Coast Guard District Commander and the Coast Guard chain of command. Disputes, if any, concerning employment of resources will be referred to the Chief of Staff, United States Army, and the Commandant, United States Coast Guard, for resolution.

SECTION IV

PLANS

Coast Guard District Commanders, in coordination with the Commanding Generals of the appropriate United States numbered Armies, will prepare plans for employment of Coast Guard resources during civil disturbances.

SECTION V

TRAINING

The Commandant, US Coast Guard is responsible for the training of Coast Guard personnel for their civil disturbance role and will familiarize these personnel with the general guidance concerning use of force and the conduct and deportment expected of individual members of Federal civil disturbance forces, as outlined in the DA Civil Disturbance Plan.

SECTION VI

REPORTS

The commander of Coast Guard elements employed as part of a Federal civil disturbance task force will render reports as



243

ANNEX M (MEMORANDUM OF UNDERSTANDING) TO DEPARTMENT OF THE  
ARMY CIVIL DISTURBANCE PLAN (U)

requested by the task force commander. A standing operating procedure for submission of reports by Coast Guard elements will be included in the plan for employment of Coast Guard resources.

SECTION VII

COSTS

1. Costs incurred will be borne by the respective Services.
2. Logistical support will be on a reimbursable basis and will wherever possible be based upon cross-service agreements.

Done this 30th day of August, 1968, at the City of Washington.

FOR THE UNITED STATES ARMY:

FOR THE UNITED STATES COAST GUARD:

Signed/G. R. MATHER

Signed/R. W. GOEHRING

G. R. MATHER  
Lieutenant General, USA  
Director for Civil Disturbance  
Planning and Operations

R. W. GOEHRING  
Rear Admiral, US Coast Guard  
Chief, Office of Operations

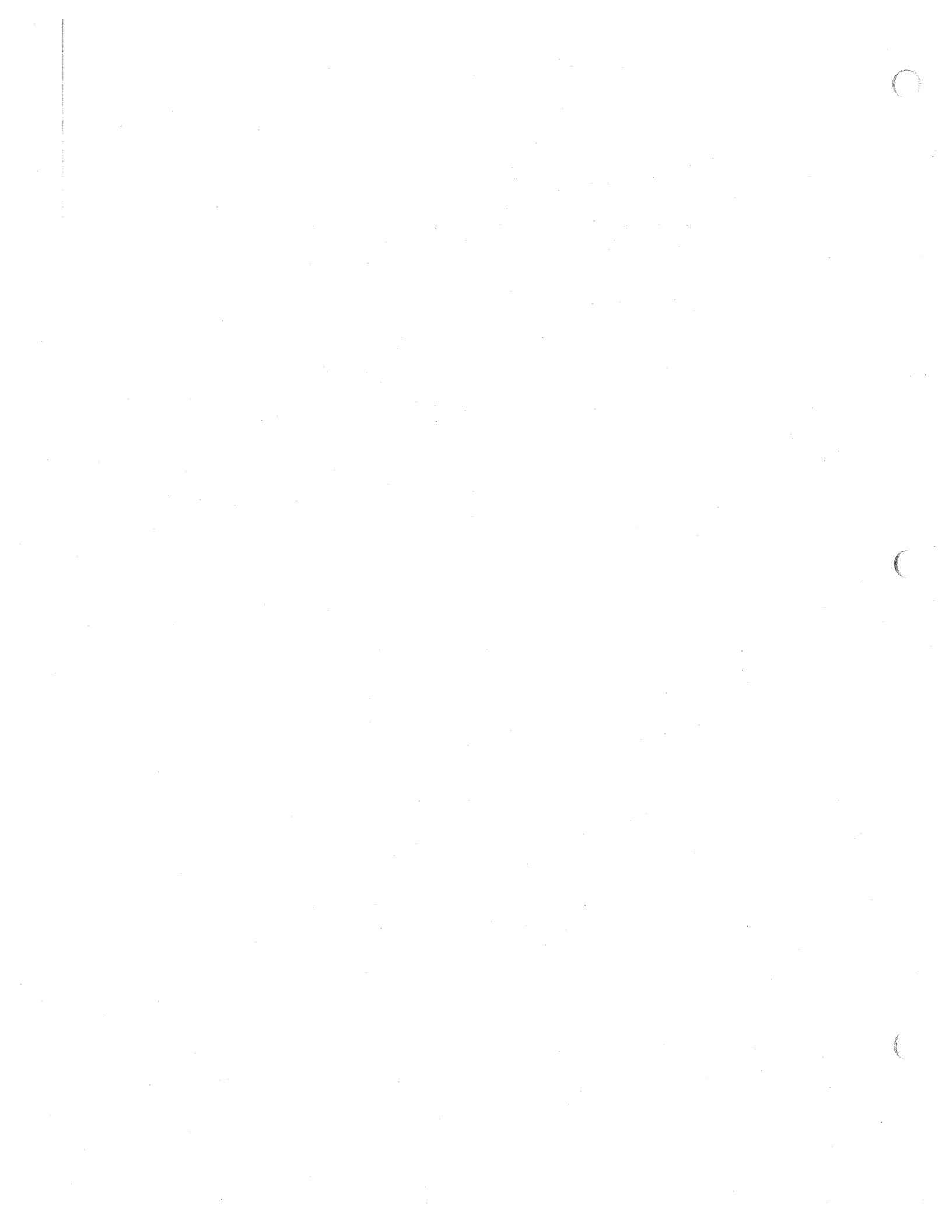

245

ANNEX Z (DISTRIBUTION) TO DEPARTMENT OF THE ARMY CIVIL  
DISTURBANCE PLAN (U)

<u>ORGANIZATION</u>	<u>NUMBER OF COPIES</u>
DOJ	6
FBI	6
DOD AGENCIES	
OSD	6
OJCS	12
DCA	12
DIA	6
DSA	6
UNIFIED/SPECIFIED COMMANDS	
ALCOM	6
LANTCOM	6
CONAD	2
USEUCOM	6
PACOM	6
USSOUTHCOM	6
USSTRICOM	6
SAC	2
DA	
SA	4
CofSA	2
VCofSA	6
SGS	10
DCSPER	12
DCSOPS	10
DCSLOG	10
ACSFOR	10
ACSI	10
ACSC-E	10
CORC	2
CRD	2
COA	4
CAR	3
CINFO	2
TAG	2
TIG	2
TJAG	2
TPMG	2
TSG	2
CofEngrs	2
CofCH	2
CMH	2
OPO	2
* CNGB	53
USCONARC	12
USASTRATCOM	5
USACDC	3

ANNEX Z (DISTRIBUTION) TO DEPARTMENT OF THE ARMY CIVIL  
DISTURBANCE PLAN (U)

<u>ORGANIZATION</u>	<u>NUMBER OF COPIES</u>
USAINTC	6
USAMC	3
USARADCOM	3
USASA	3
MTMTS	3
FIRST US ARMY	5
THIRD US ARMY	5
FOURTH US ARMY	5
FIFTH US ARMY	5
SIXTH US ARMY	5
MDW	2
USAJFKCENSPWAR (ABN)	2
III CORPS	4
XVIII ABN CORPS	4
1ST ARMD DIV	4
2D ARMD DIV	4
5TH INF DIV (MECH)	4
24TH INF DIV	4
82D ABN DIV	4
DN	
CNO	10
CMC	10
EASTERN SEA FRON	2
WESTERN SEA FRON	2
** NAVAL DISTRICTS (CONUS)	11
FMFLANT	2
FMFPAC	2
2D MAR DIV	2
5TH MAR DIV	2
DAF	
CSAF	25
US COAST GUARD	6
TASK FORCE HQ (25 designated)	25
SERVICE SCHOOLS	
NATIONAL WAR COLLEGE	5
INDUSTRIAL COLLEGE OF THE ARMED FORCES	5
ARMED FORCES STAFF COLLEGE	5
US ARMY WAR COLLEGE	5
US ARMY COMMAND AND GENERAL STAFF COLLEGE	5
US ARMY ADJUTANT GENERAL'S SCHOOL	5
US ARMY AIR DEFENSE SCHOOL	5
US ARMY ARMOR SCHOOL	5
US ARMY ARTILLERY AND MISSILE SCHOOL	5
US ARMY CHAPLAIN SCHOOL	5
US ARMY CHEMICAL SCHOOL	5
US ARMY CIVIL AFFAIRS SCHOOL	5

247

ANNEX Z (DISTRIBUTION) TO DEPARTMENT OF THE ARMY CIVIL  
DISTURBANCE PLAN (U)

<u>ORGANIZATION</u>	<u>NUMBER OF COPIES</u>
US ARMY ENGINEER SCHOOL	5
US ARMY FINANCE SCHOOL	5
US ARMY INFANTRY SCHOOL	5
US ARMY INTELLIGENCE SCHOOL	5
US ARMY ORDNANCE SCHOOL	5
US ARMY MILITARY POLICE SCHOOL	5
US ARMY QUARTERMASTER SCHOOL	5
US ARMY SIGNAL SCHOOL	5
US ARMY SPECIAL WARFARE SCHOOL	5
US ARMY TRANSPORTATION SCHOOL	5

\*One copy for each state AG

\*\*One copy for each Naval District

Z-3



~~CONFIDENTIAL~~  
UNCLASSIFIED

0000523

GROUP - 3  
Downgraded at 12 year intervals;  
Not automatically declassified.

DECLASSIFIED  
DAMH-HSR-D# 8  
DATE: 10 March 88

UNCLASSIFIED

~~CONFIDENTIAL~~

